

Jalapeno is based on an IPQ4018 SoC from Qualcomm, which is extremely powerful quad core 700MHz CPU Cortex A7 CPU with NEON (high-performance media engine), ideal for routers, gateways and access points. It is a surface mountable, dual-sided, Wi-Fi enabled Linux module.

It comes with a high-power (23 dBm per chain) dual-band concurrent radio supporting 802.11ac Wave2 technology (2x2 MiMo) reaching 1.167 Gbps data rate. USB 3.0, USB 2.0, I2S, UART, GPIO are the interfaces available on the module together with two Gigabit Ethernet ports. SoC has hardware NAT engine and high-end security features like crypto engine, secure boot and others.

OpenWRT linux distribution source code is available on GitHub <https://github.com/8devices> and is supported by our growing community on <http://www.8devices.com/community> forum.

Quick specs

- 802.11 a/b/g/n/ac Wave 2, 2.4 and 5 GHz, 2x2 MIMO, 300 and 867 Mbps data rate, 23 dBm per chain output power
- U.FL connectors for external antenna
- 128 MB NAND and 8 MB NOR FLASH, 256 MB DDR3 RAM
- Linux friendly, OpenWRT flash image and source code are available for download on www.8devices.com/wiki_jalapeno
- CPU – IPQ 4018 (700 MHz quad core Cortex A7)
- 23 dBm per chain output power dual-band concurrent radio with dedicated Tensilica CPU and 802.11ac Wave 2 support
- 32 by 47 mm size
- Surface mountable, dual-side design
- Available interfaces - USB 2.0, USB 3.0, I2S, UART, GPIO, JTAG and 2 x 1000 Base-T Ethernet ports

Table of Contents

1.	Block diagram	3
2.	Pinout Information	4
3.	Electrical characteristics	8
3.1.	Power consumption	8
3.2.	Operating conditions	8
3.3.	Power ratings	8
3.4.	Digital I/O characteristics for 3.3V I/O	9
4.	PCB footprint	10
4.1	Soldering paste footprint	10
5.	Reflow profile recommendations	11
5.1.	Reflow profile parameters	11
5.2.	Reflow profile	11
6.	Radio characteristics	12
7.	Module dimensions	13
8.	Development board	14
8.1.	Jalapeno DVK	14
8.2.	Jalapeno DVK drawing with heatsink	14
8.3.	Jalapeno DVK drawing without heatsink	15
9.	Heatsink size recommendations	16
10.	Jalapeno packaging and ordering info	17
10.1.	Jalapeno tray dimensions	17
10.2	Standard packaging box dimensions	17
10.3	Ordering part numbers	17
11.	Document Revision History	18

1. Block diagram

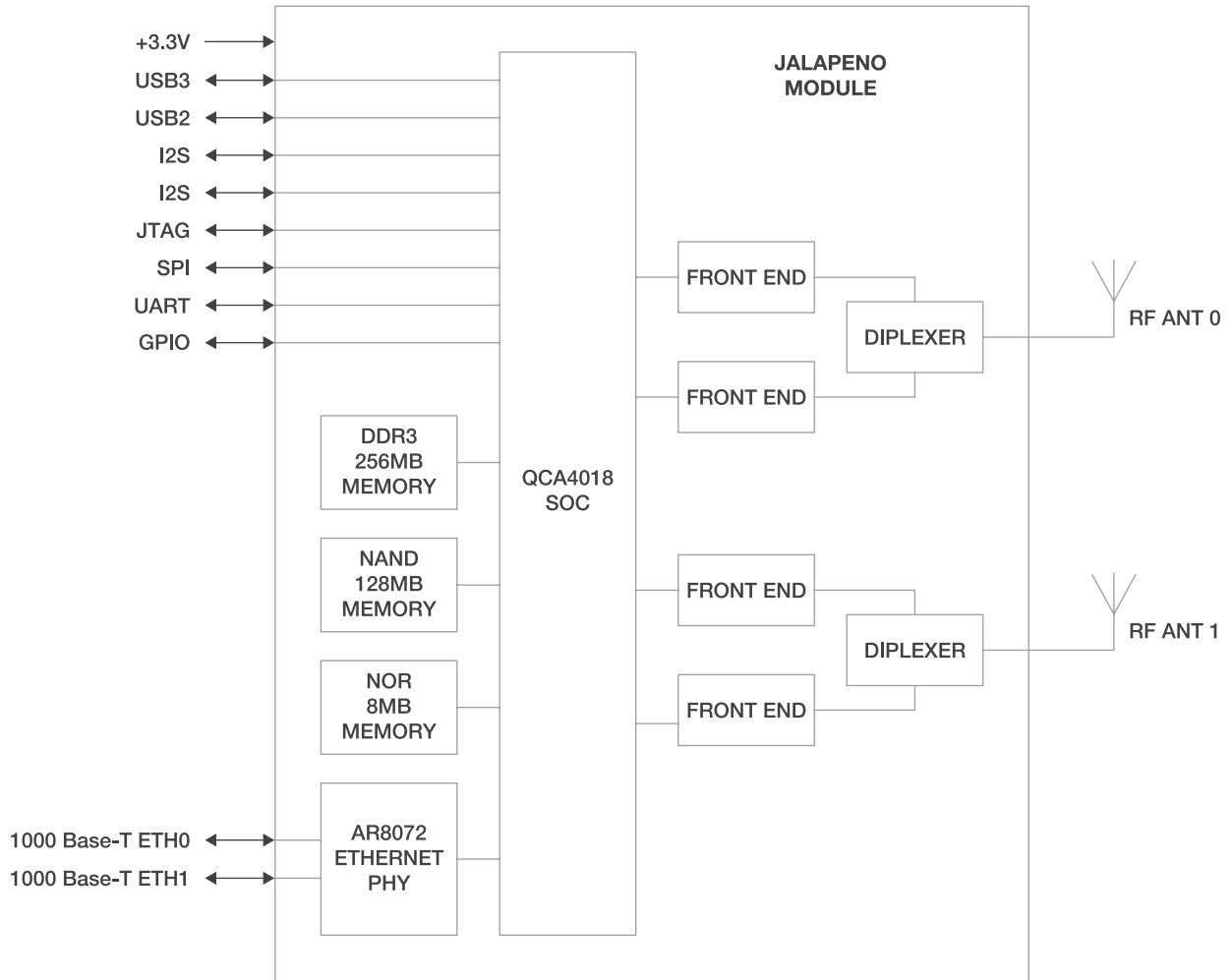

2. Pinout Information

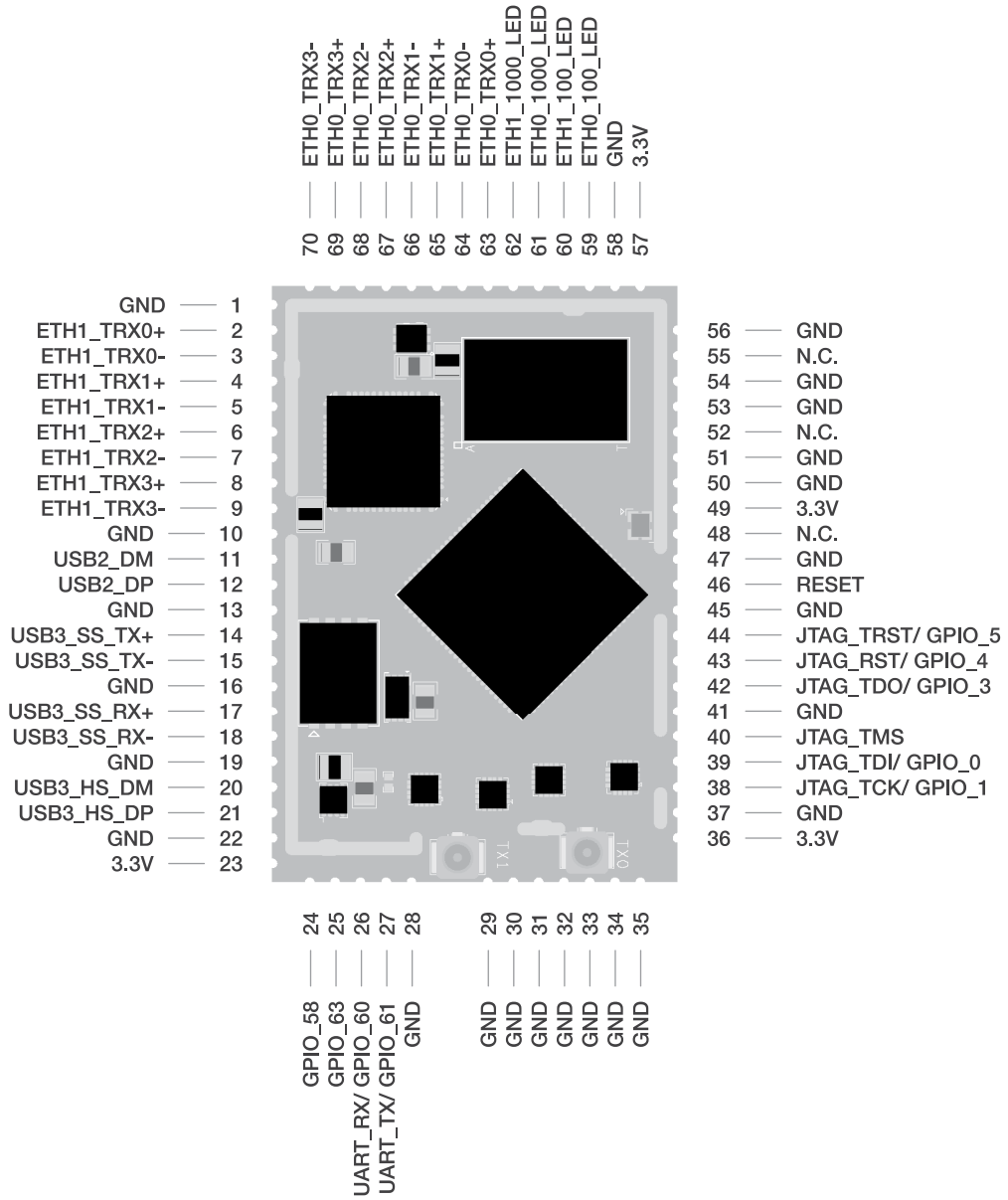

TABLE 2.1. PINOUT INFORMATION

Pin	Name	GPIO function select	Configurable function	Voltage (V)	Type	Description
1	GND	-	-	-	-	Ground connection
2	ETH1_TRX0+	-	-	-	AI, AO	1000 Base-T output positive
3	ETH1_TRX0-	-	-	-	AI, AO	1000 Base-T output negative
4	ETH1_TRX1+	-	-	-	AI, AO	1000 Base-T output positive
5	ETH1_TRX1-	-	-	-	AI, AO	1000 Base-T output negative
6	ETH1_TRX2+	-	-	-	AI, AO	1000 Base-T output positive
7	ETH1_TRX2-	-	-	-	AI, AO	1000 Base-T output negative
8	ETH1_TRX3+	-	-	-	AI, AO	1000 Base-T output positive
9	ETH1_TRX3-	-	-	-	AI, AO	1000 Base-T output negative
10	GND	-	-	-	-	Ground connection
11	USB2_DM	-	-	-	AI, AO	USB 2.0 data negative
12	USB2_DP	-	-	-	AI, AO	USB 2.0 data positive
13	GND	-	-	-	-	Ground connection
14	USB3_SS_TX+	-	-	-	AO	USB 3.0 SuperSpeed transmitter positive
15	USB3_SS_TX-	-	-	-	AO	USB 3.0 SuperSpeed transmitter negative
16	GND	-	-	-	-	Ground connection
17	USB3_SS_RX+	-	-	-	AI	USB 3.0 SuperSpeed receiver positive
18	USB3_SS_RX-	-	-	-	AI	USB 3.0 SuperSpeed receiver negative
19	GND	-	-	-	-	Ground connection
20	USB3_HS_DM	-	-	-	AI, AO	USB 2.0 data negative
21	USB3_HS_DP	-	-	-	AI, AO	USB 2.0 data positive
22	GND	-	-	-	-	Ground connection
23	3.3V	-	-	-	PI	3.3V power supply
24	GPIO58	0	GPIO	3.3	-	-
		2	LED[2]	3.3	O	-
		5	smart_ant6	3.3	IO	-
25	GPIO63	0	GPIO	3.3	-	-
		5	Audio_txd[1]	3.3	O	Audio transmit data
		6	Audio_rxd	3.3	I	Audio receive data
26	UART_RX/GPIO60	0	GPIO	3.3	-	-
		2	blsp_uart0_rxd(1)	3.3	I	UART RX
		4	smart_ant4	3.3	IO	-
		5	LED[0]	3.3	O	-
		6	audio_txclk	3.3	IO	Audio transmit bit clock
		7	audio_rxclk	3.3	IO	Audio receive bit clock

Pin	Name	GPIO function select	Configurable function	Voltage (V)	Type	Description
27	UART_TX/GPIO61	0	GPIO	3.3	-	-
		2	blsp_uart0_txd	3.3	O	UART TX
		4	smart_ant5	3.3	IO	-
		5	audio_txfsync	3.3	IO	Audio transmit frame sync
		6	audio_rxfsync	3.3	IO	Audio receiver frame sync
		7	LED[1]	3.3	O	-
			boot_config(14)	3.3	I	-
28	GND	-	-	-	-	Ground connection
29	GND	-	-	-	-	Ground connection
30	GND	-	-	-	-	Ground connection
31	GND	-	-	-	-	Ground connection
32	GND	-	-	-	-	Ground connection
33	GND	-	-	-	-	Ground connection
34	GND	-	-	-	-	Ground connection
35	GND	-	-	-	-	Ground connection
36	3.3V	-	-	-	PI	3.3V power supply
37	GND	-	-	-	-	Ground connection
38	JTAG_TCK/GPIO1	0	GPIO	3.3	-	-
		1	JTAG_TCK	3.3	I	JTAG test clock
39	JTAG_TDI/GPIO0	0	GPIO	3.3	-	-
		1	JTAG_TDI	3.3	I	JTAG test data in
40	JTAG_TMS	0	GPIO	3.3	-	-
		1	JTAG_TMS	3.3	I	JTAG test mode state
41	GND	-	-	-	-	Ground connection
42	JTAG_TDO/GPIO3	0	GPIO	3.3	-	-
		1	JTAG_TDO	3.3	O	JTAG test data out
		-	boot_config(0)	3.3	I	-
43	JTAG_RST_N/ GPIO4	0	GPIO	3.3	-	-
		1	JTAG_RST_N	3.3	I	JTAG reset for debug
44	JTAG_TRST_N/ GPIO5	0	GPIO	3.3	-	-
		1	JTAG_TRST_N	3.3	I	JTAG test reset
45	GND	-	-	-	-	Ground connection
46	Reset	-	Module reset		I	0 - reset, 1 - run
47	GND	-	-	-	-	Ground connection
48	NC	-	-	-	-	Not connected
49	3.3V	-	-	-	PI	3.3V power supply
50	GND	-	-	-	-	Ground connection

Pin	Name	GPIO function select	Configurable function	Voltage (V)	Type	Description
51	GND	-	-	-	-	Ground connection
52	NC	-	-	-	-	Not connected
53	GND	-	-	-	-	Ground connection
54	GND	-	-	-	-	Ground connection
55	NC	-	-	-	-	Not connected
56	GND	-	-	-	-	Ground connection
57	3.3V	-	-	-	PI	3.3V power supply
58	GND	-	-	-	-	Ground connection
59	ETH0_100_LED	-	-	-	AO	LED output for 100 Base-T activity
60	ETH1_100_LED	-	-	-	AO	LED output for 100 Base-T activity
61	ETH0_1000_LED	-	-	-	AO	LED output for 1000 Base-T activity
62	ETH1_1000_LED	-	-	-	AO	LED output for 1000 Base-T activity
63	ETH0_TRX0+	-	-	-	AI, AO	1000 Base-T output positive
64	ETH0_TRX0-	-	-	-	AI, AO	1000 Base-T output negative
65	ETH0_TRX1+	-	-	-	AI, AO	1000 Base-T output positive
66	ETH0_TRX1-	-	-	-	AI, AO	1000 Base-T output negative
67	ETH0_TRX2+	-	-	-	AI, AO	1000 Base-T output positive
68	ETH0_TRX2-	-	-	-	AI, AO	1000 Base-T output negative
69	ETH0_TRX3+	-	-	-	AI, AO	1000 Base-T output positive
70	ETH0_TRX3-	-	-	-	AI, AO	1000 Base-T output negative

PI - Power input

IO - digital bi-directional signal

O - digital output

I - digital input

AO - analog output

AI - analog input

3. Electrical characteristics

3.1. POWER CONSUMPTION

Scenario	Voltage, V	Current, A	Power, W
Idle without beacons	5	0.41	2.05
Idle with beacons	5	0.68	3.4
MCS0 HT20	5	2.55	12.75
MCS9 VHT80/HT40 (Highest rates)	5	1.78	8.9

3.2. OPERATING CONDITIONS

The module can operate in a wide temperature range and different conditions depending on the enclosure. The following guidelines guarantee that it will work correctly.

Parameter	Units	Min	Max
Working environment	°C	0	55
Storage environment	°C	-40	70
Humidity	%RH	10	90
Storage humidity	%RH	5	90

3.3. POWER RATINGS

Parameter	Units	Min	Nominal	Max
3.3V power supply	V	3.13	3.3	3.46

Power supply

It is recommended to use pin 23, 36, 49 and 57 to give power supply to the module.

3.4 DIGITAL I/O CHARACTERISTICS FOR 3.3V I/O

Parameter	Comments	Min	Max	Units	
V_{IH}	High-level input voltage	CMOS/ Schmitt	2	3.6	V
V_{IL}	Low-level input voltage	CMOS/ Schmitt	-0.3	0.4	V
V_{SHYS}	Schmitt hysteresis voltage	-	-	mV	
I_{IH}	Input high leakage current _{1,2}	No pulldown	-	1	μ A
I_{IL}	Input low leakage current _{1,2}	No pullup	-1	-	μ A
I_{IHPD}	Input high leakage current _{1,3}	With pulldown	10	60	μ A
I_{ILPU}	Input low leakage current _{2,3}	With pullup	-60	-10	μ A
V_{OH}	High-level output voltage ₄	CMOS, at pin-rated drive strength	3.0	3.6	V
V_{OL}	Low-level output voltage ₄	CMOS, at pin-rated drive strength	-0.3	0.4	V
I_{OZH}	Tri-state leakage current ₁	Logic high output, no pulldown	-	1	μ A
I_{OZL}	Tri-state leakage current ₂	Logic low output, no pullup	-1	-	μ A
I_{OZHDP}	Tri-state leakage current _{1,3}	Logic high output with pulldown	10	60	μ A
I_{OZLPU}	Tri-state leakage current _{2,3}	Logic low output with pullup	-60	-10	μ A
C_{IN}	Input capacitance ₅	-	-	5	pF

4. PCB footprint

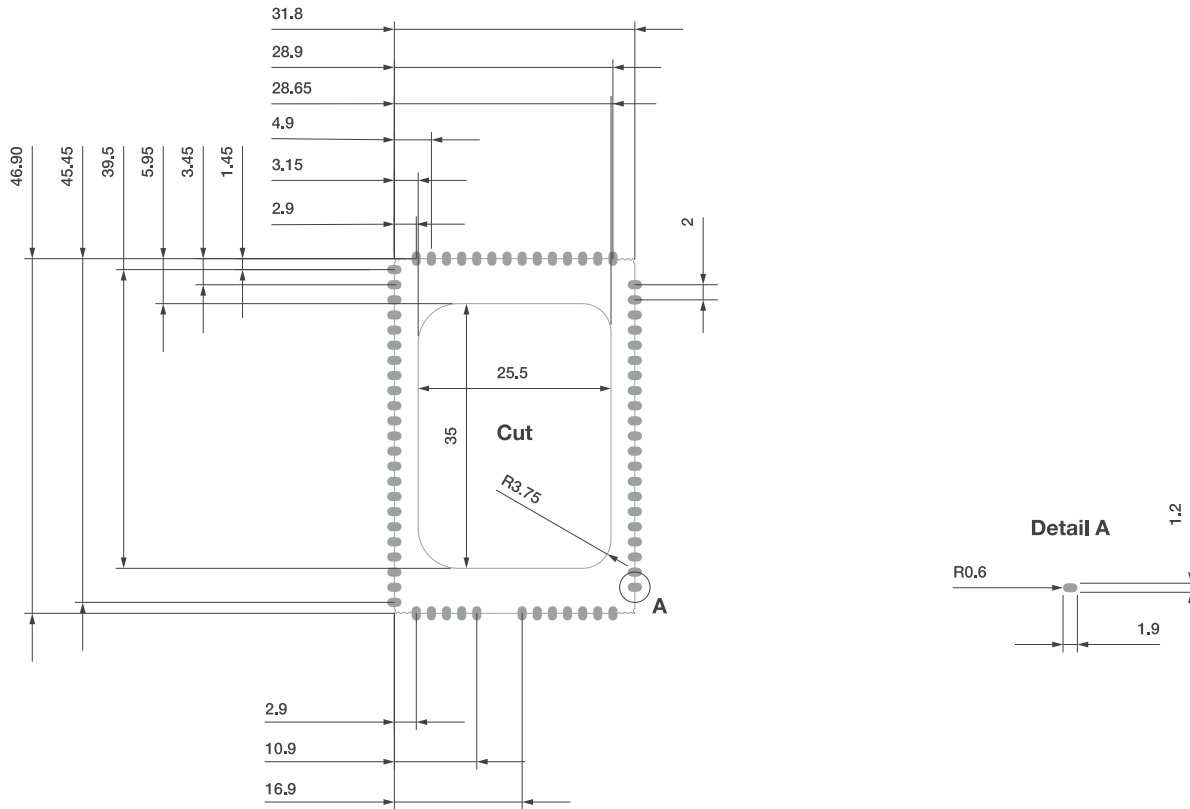

4.1. SOLDERING PASTE FOOTPRINT

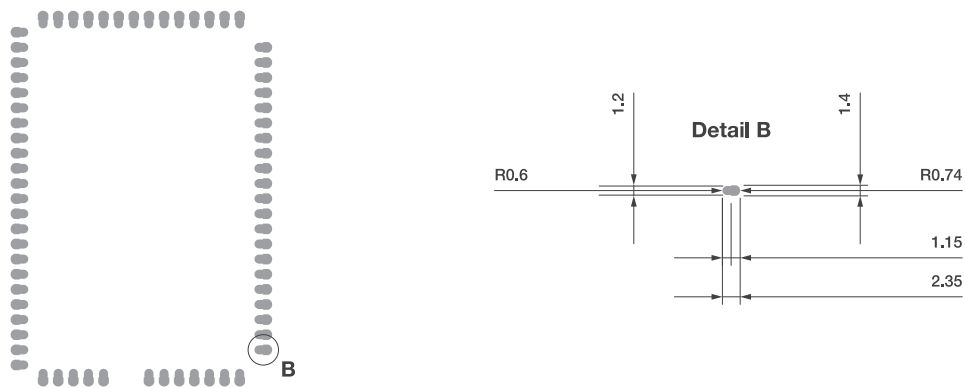

5. Reflow profile recommendations

5.1. REFLOW PROFILE PARAMETERS

Reflow profile recommendation	
Ramp up rate	3°C/second max
Maximum time maintained above 217°C	120 seconds
Peak temperature	250°C
Maximum time within 5°C of peak temperature	20 seconds
Ramp down rate	6°C/second max

5.2. REFLOW PROFILE

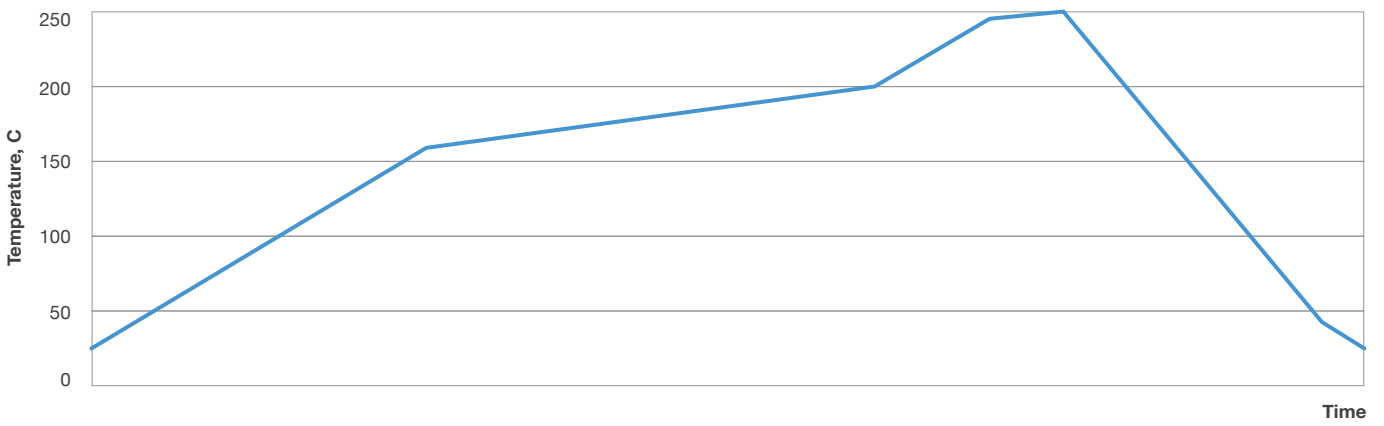

6. Radio characteristics

TABLE-6.1. 2.4 GHZ RADIO CHARACTERISTICS

2.4 GHz 802.11AC (20 MHz)	Data rate (Mbps)	14.4	28.9	43.3	57.8	86.7	115.6	130.3	144.4	173.3
	Sensitivity (dB)	-93	-90	-88	-85	80	-76	-74	-72	-68
	Output power (dBm)	22	20	19	19	18	18	18	17	17

2.4 GHz 802.11AC (40 MHz)	Data rate (Mbps)	30	60	90	120	180	240	270	300	360	400
	Sensitivity (dBm)	-90	-88	-85	-82	-77	-73	-73	-70	-66	-64
	Output power (dBm)	21	19	18	18	18	18	17	17	17	17

TABLE-6.2. 5 GHZ RADIO CHARACTERISTICS

5 GHz 802.11AC (20 MHz)	Data rate (Mbps)	14.4	28.9	43.3	57.8	86.7	115.6	130.3	144.4	173.3
	Sensitivity (dB)	-92	-89	-86	-83	-80	-76	-74	-73	-68
	Output power (dBm)	22	20	19	19	18	18	18	17	17

5 GHz 802.11AC (40 MHz)	Data rate (Mbps)	30	60	90	120	180	240	270	300	360	400
	Sensitivity (dB)	-89	-86	-84	-81	-78	-73	-72	-70	-66	-67
	Output power (dBm)	21	19	18	18	18	18	17	17	17	17

5 GHz 802.11AC (80 MHz)	Data rate (Mbps)	65	130	195	260	390	520	585	650	780	866.7
	Sensitivity (dB)	-86	-83	-80	-77	-74	-70	-69	-67	-63	-61
	Output power (dBm)	21	19	18	18	18	18	17	17	17	17

7. Module dimensions

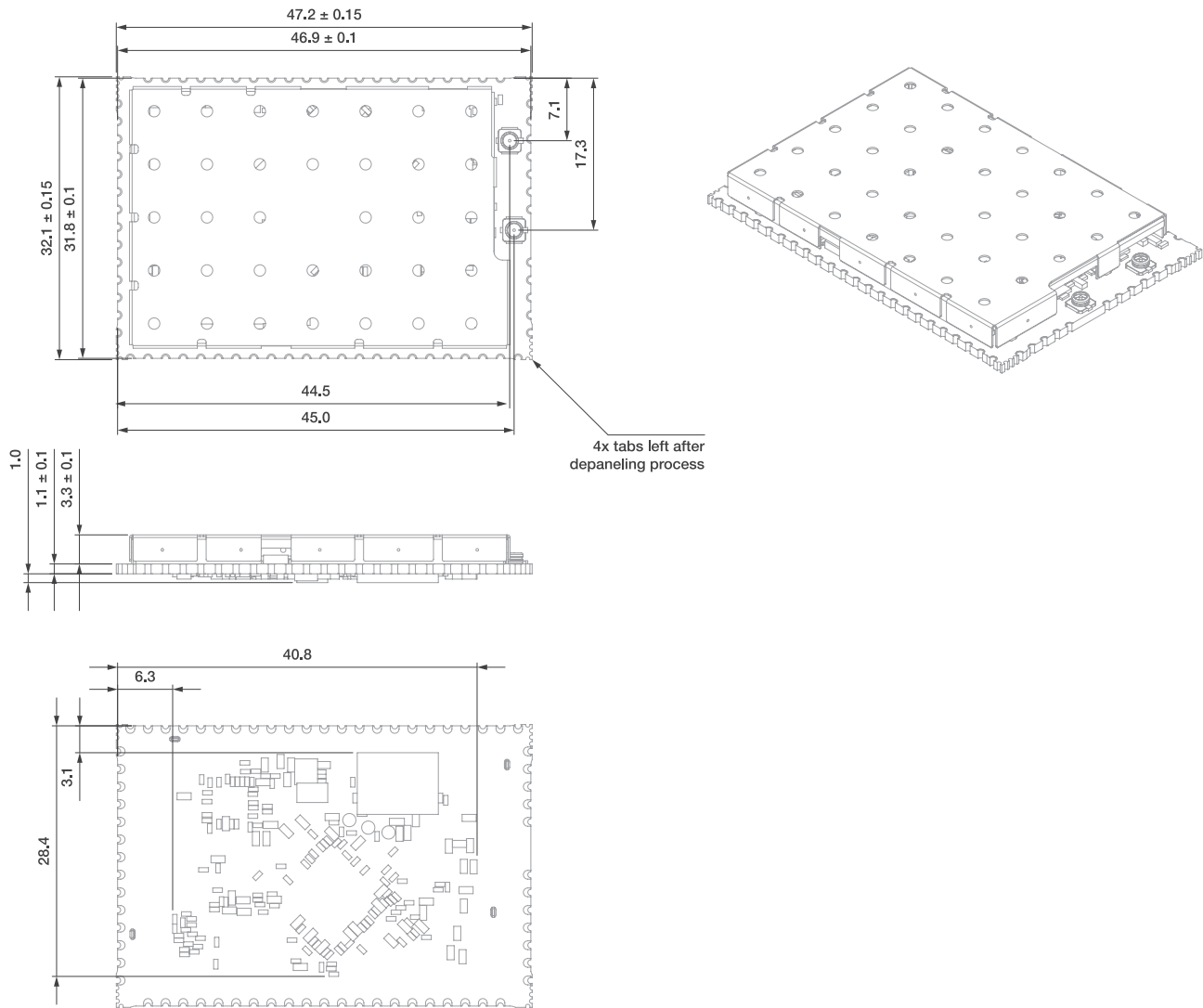

8. Development board

8.1. JALAPENO DVK

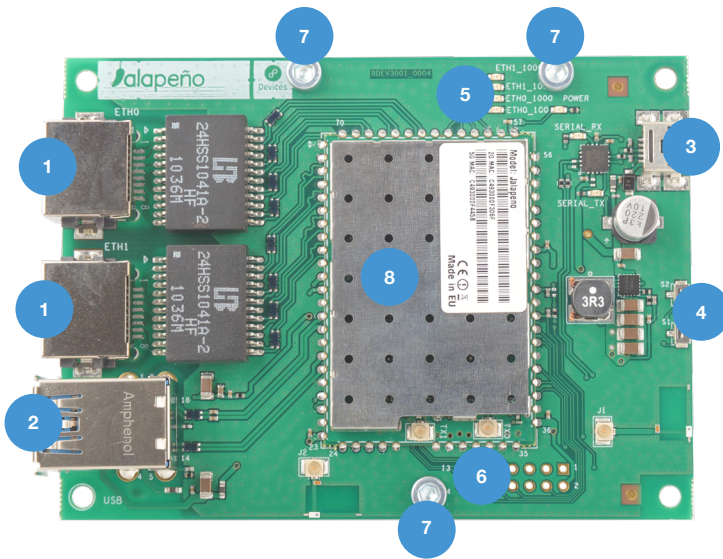

- 1 - 2 x 1000 Base-T Ethernet ports
- 2 - 2 x USB Type-A sockets (2.0 and 3.0)
- 3 - Mini USB Type-A socket (console + power)
- 4 - Buttons (reset and user - GPIO connected)
- 5 - External LEDs
- 6 - 2.45 mm pitch prototyping are holes
- 7 - Heatsink mounting screws
- 8 - Jalapeno module

8.2. JALAPENO DVK DRAWING WITH HEATSINK

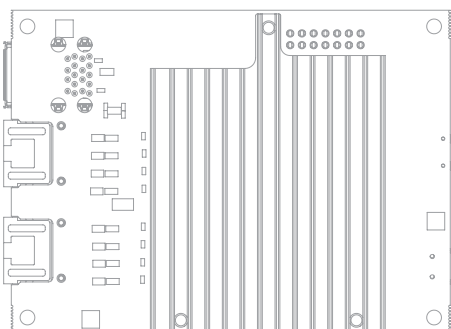
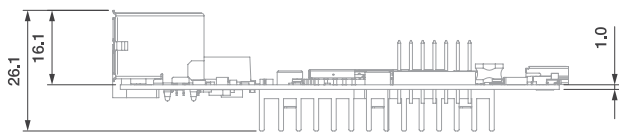
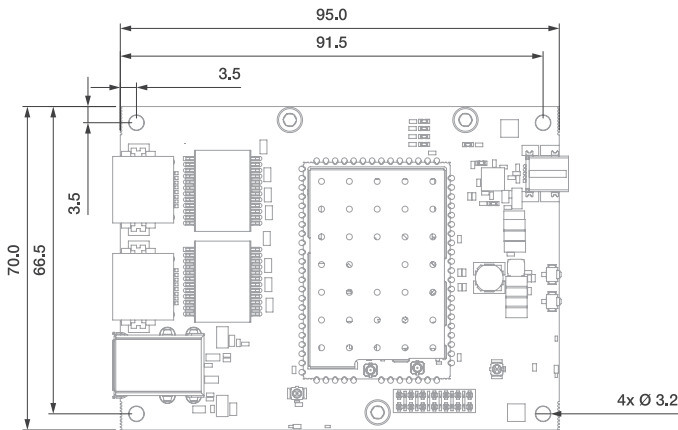

8.3. JALAPENO DVK DRAWING WITHOUT HEATSINK

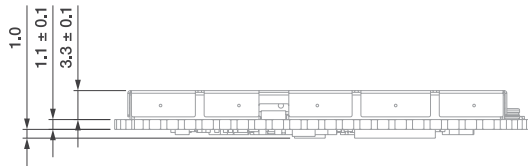
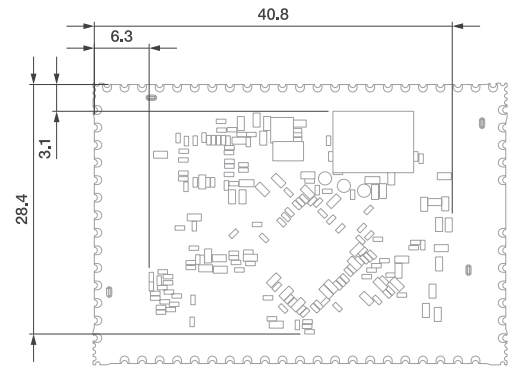
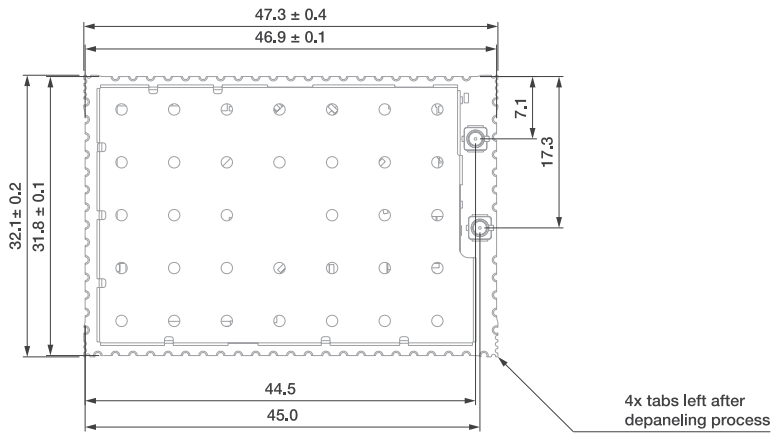

9. Heatsink size recommendations

It is essential to use heatsink for the hardware designs based on Jalapeno module. Heatsink should be able to dissipate at least 7W and the recommended area is 175 cm². It should be directly attached to the bottom side of Jalapeno module. Maximum ambient temperature with the given heatsink is +85°C.

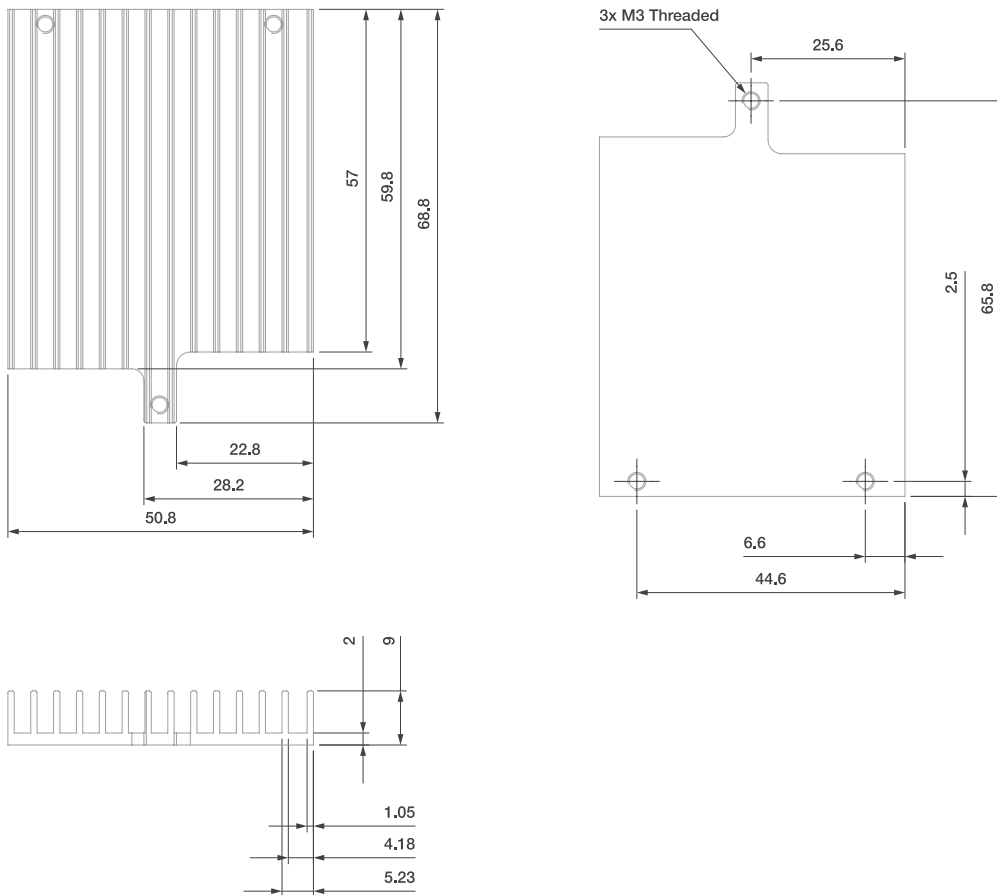

New feature:

<https://www.8devices.com/wiki/jalapeno:build>

You can build a new firmware with added fixes, which allow to check SoC temperature from serial.

Command:

```
cat /sys/class/ieee80211/phy*/device/hwmon/hwmon2/temp1_input
```

Radio has to be turned on.

Temperature is shown in mili-deg C.

10. Jalapeno packaging and ordering info

10.1. JALAPENO TRAY DIMENSIONS

Jambutan modules are packed into trays. Each tray fits 20 modules. Every 5 trays are vacuum sealed and contains 100 modules each. Standard packing box contains 500 modules.

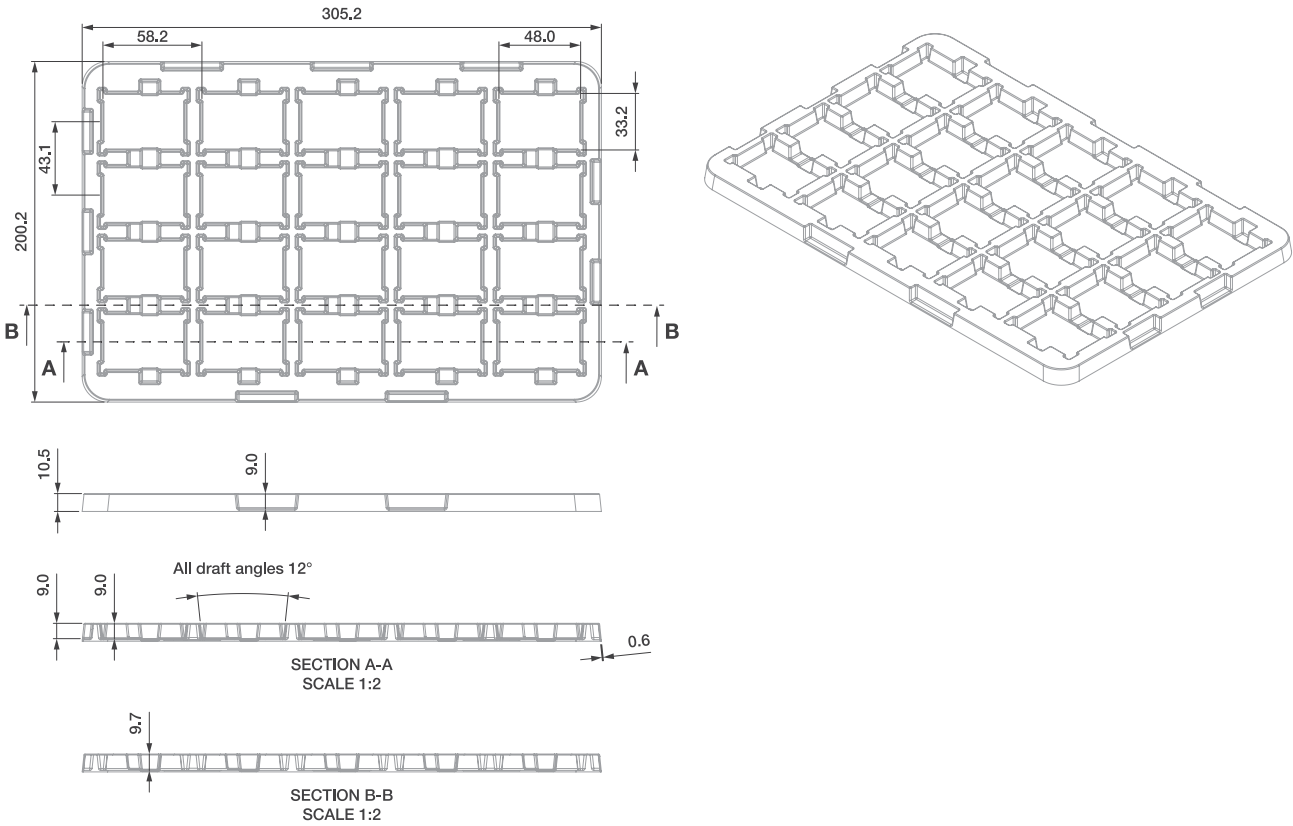

10.2. STANDARD PACKAGING BOX DIMENSIONS

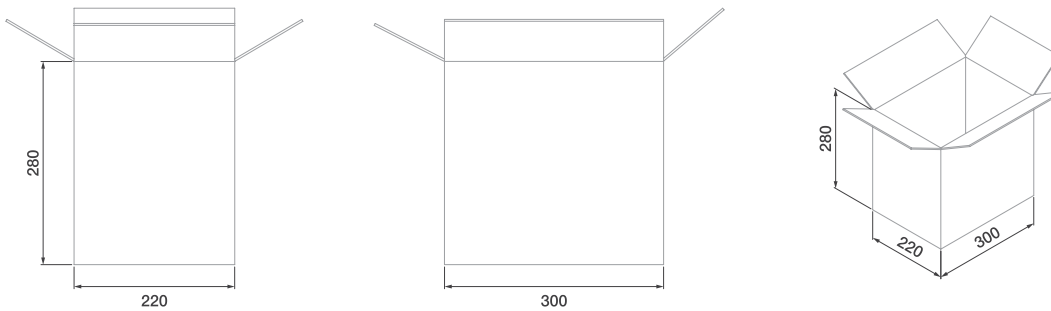

10.3. ORDERING PART NUMBERS

Order Number	Description
Jalapeno	Jalapeno module, commercial temperature range 0°C to 65°C, IPQ-4018 SoC
Jalapeno DVK	Development kit, based on Jalapeno module, IPQ-4018 SoC

11. Document Revision History

Revision	Revision Date	Description
V1.0	02-20-2022	Initial release in a new format