

Rambutan is based on QCA 9557 or 9550 SoC and comes in two temperature ranges: commercial* (Rambutan) and industrial** (Rambutan-I). It is a surface mountable, dual-sided, Wi-Fi enabled Linux module. Dual-band radio (2.4 or 5 GHz), powerful 720 MHz CPU, 300 Mbps data-rate, 128 MB RAM and Flash and a development kit with multiple interfaces (e.g. Gigabit Ethernet port, PCIe, hardware SPI etc.) are the main advantages of the Rambutan module. OpenWRT linux distribution source code is available on GitHub www.github.com/8devices and is supported by our growing community on www.8devices.com/community forum.

*Commercial temperature range: 0 - 65° C **Industrial temperature range: -40 - 85° C

Quick specs

- 802.11 a/b/g/n, 2.4 or 5 GHz, 2x2 MIMO, 300 Mbps data rate, 21 dBm per chain output power
- U.FL connectors for external antenna
- 128 MB FLASH, 128 MB DDR2 RAM
- Linux friendly , OpenWRT flash image and source code are available for download on www.8devices.com/wiki_rambutan
- CPU – QCA 9557 or 9550 (720 MHz)
- 32 by 47 mm size
- Surface mountable, dual-side design
- Industrial and commercial temperature range models
- Available interfaces - 2 x USB 2.0, 2 x serial port, 1 x 100 Base-T Ethernet port (2nd 1000 Base-T Ethernet port on the Rambutan-DVK is connected to the module using SGMII interface), I2S, SPI, I2C, PCIe, GPIO, MDIO

Table of Contents

1. Block diagram	3
-------------------------	----------

2. Pinout Information	4
------------------------------	----------

3. Electrical characteristics	7
3.1. General GPIO and MDIO DC electrical characteristics	7
3.2. SGMII driver AC characteristics	8
3.3. MDIO timing characteristics	8
3.4. Mini PCI express reset DC characteristics	8
3.5. Bootstrap	8
3.6. GPIO	9
3.7. Power supply	9
3.8. Power ratings	9
3.9. Software	9
3.10. Rambutan-I unique features	9
3.11. Operating conditions	9

4. PCB footprint	10
4.1 Soldering paste footprint	10

5. Reflow profile recommendations	11
5.1 Reflow profile parameters	11
5.2 Reflow profile	11

6. Radio characteristics	12
---------------------------------	-----------

7. Module dimensions	13
-----------------------------	-----------

8. Development board	14
8.1. DVK dimensions	14
8.2. Rambutan DVK	15
8.3. DIP switch combinations for bootstrap and interface modes	16
8.4. How to use second USB port?	15

9. Rambutan packaging and ordering info	17
9.1 Rambutan tray dimensions	17
9.2 Standard packaging box dimensions	17
9.3 Ordering part numbers	17

10. Document revisions history	18
---------------------------------------	-----------

1. Block diagram

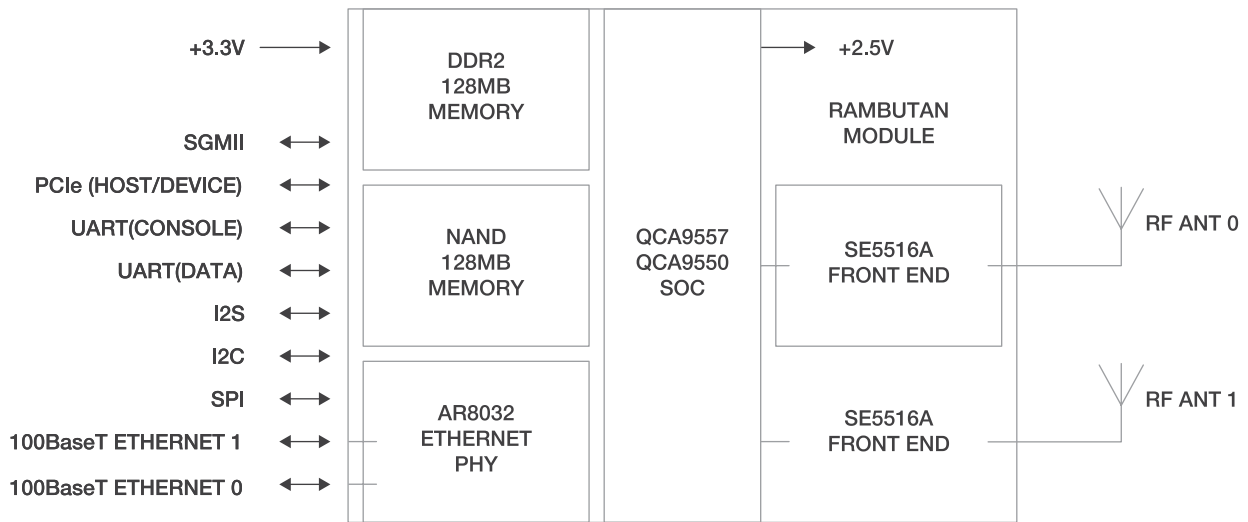

2. Pinout Information

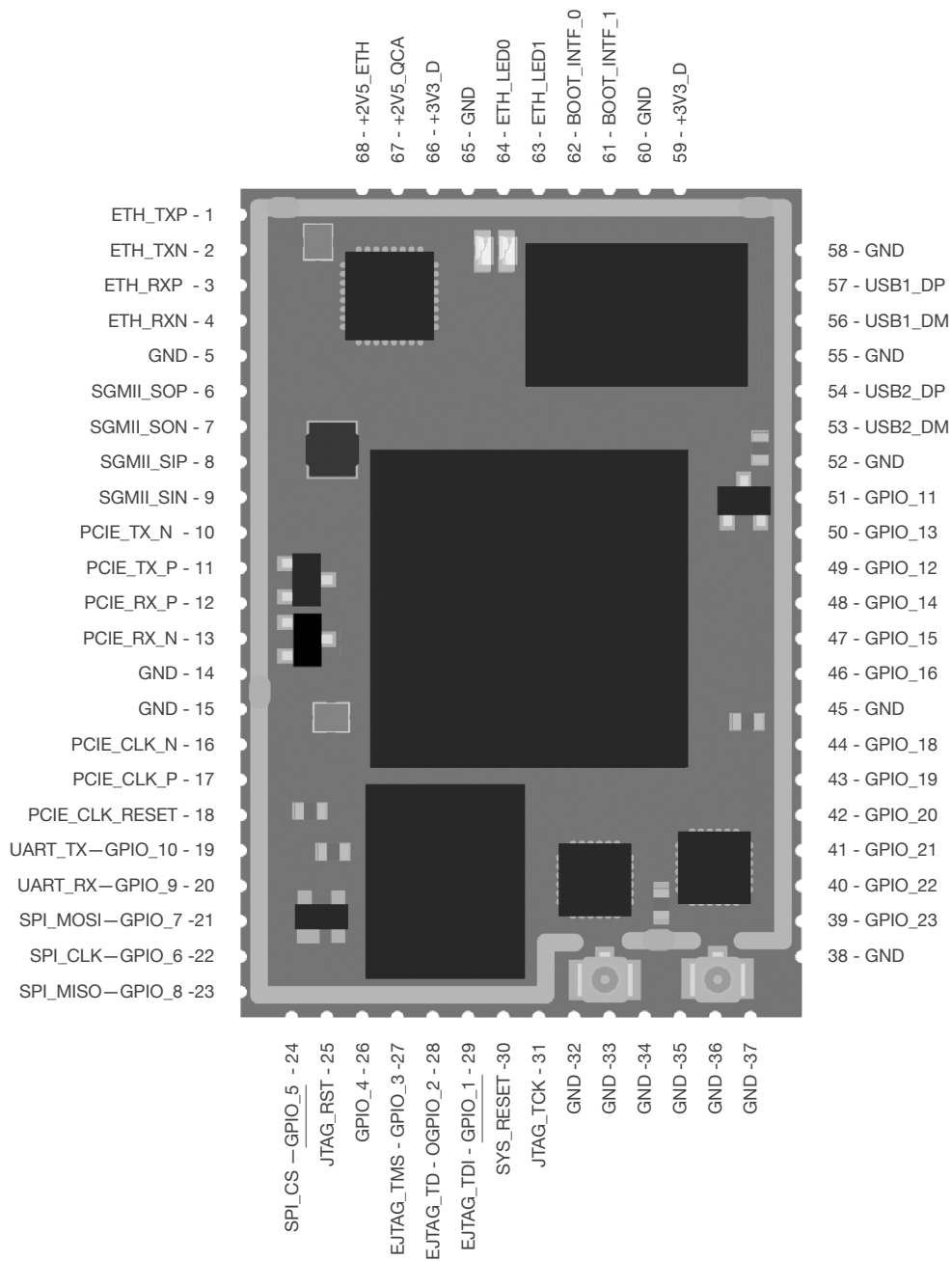

Pin	Name	I/O	Description
1	ETH_TXP	OA	LAN port positive TX connection
2	ETH_TXN	OA	LAN port negative TX connection
3	ETH_RXP	IA	LAN port positive RX connection
4	ETH_RXN	IA	LAN port negative RX connection
5	GND	-	Ground connection
6	SGMII_SOP	OA	SGMII positive TX connection
7	SGMII_SON	OA	SGMII negative TX connection
8	SGMII_SIP	IA	SGMII positive RX connection
9	SGMII_SIN	IA	SGMII negative RX connection
10	PCIE_TX_N	OA	PCIE negative TX connection
11	PCIE_TX_P	OA	PCIE positive TX connection
12	PCIE_RX_P	IA	PCIE positive RX connection
13	PCIE_RX_N	IA	PCIE negative RX connection
14	GND	-	Ground connection
15	GND	-	Ground connection
16	PCIE_CLK_N	OA	PCIE negative clock connection
17	PCIE_CLK_P	OA	PCIE positive clock connection
18	PCIE_RESET	O	PCIE reset connection
19	UART_TX (GPIO_10) Bootstrap L	O (I/O)	Serial data out
20	UART_RX (GPIO_9)	I (I/O)	Serial data in
21	SPI_MOSI (GPIO_7) Bootstrap H	O (I/O)	Data transmission from the Rambutan to an external device. On reset, SPI_MOSI (GPIO_7) is output and can directly interface with a SPI device such as a serial flash. If a serial flash is not used, these pins may be used as GPIO pins.
22	SPI_CLK (GPIO_6) Bootstrap L	O (I/O)	SPI serial interface clock
23	SPI_MISO (GPIO_8)	I/O	Data transmission from an external device to the Rambutan. On reset, SPI_MISO (GPIO_8) is input, which should be interfaced with an SPI device via a resistor divider for reliability. If a serial flash is not used, these pins may be used as GPIO pins.
24	SPI_CS (GPIO_5)	O (I/O)	SPI chip select
25	RESET	I	reset input
26	GPIO_4 Bootstrap L	(I/O)	General-purpose digital I/O pin
27	JTAG_TMS (GPIO_3)	I (I/O)	JTAG state control
28	JTAG_TDO (GPIO_2)	O (I/O)	JTAG data output
29	JTAG_TDI (GPIO_1)	I (I/O)	JTAG data input
30	SYS_RESET	O	System reset output
31	JTAG_TCK (GPIO_0)	I	JTAG clock input
32	GND	-	Ground connection
33	GND	-	Ground connection
34	GND	-	Ground connection
35	GND	-	Ground connection
36	GND	-	Ground connection
37	GND	-	Ground connection
38	GND	-	Ground connection

Pin	Name	I/O	Description
39	GPIO_23	(I/O)	General-purpose digital I/O pin
40	GPIO_22	(I/O)	General-purpose digital I/O pin
41	GPIO_21	(I/O)	General-purpose digital I/O pin
42	GPIO_20	(I/O)	General-purpose digital I/O pin (open drain)
43	GPIO_19	(I/O)	General-purpose digital I/O pin (open drain)
44	GPIO_18	(I/O)	General-purpose digital I/O pin (open drain)
45	GND	-	Ground connection
46	GPIO_16 Bootstrap L	(I/O)	General-purpose digital I/O pin
47	GPIO_15 Bootstrap L	(I/O)	General-purpose digital I/O pin
48	GPIO_14 Bootstrap L	(I/O)	General-purpose digital I/O pin
49	GPIO_12 Bootstrap L	(I/O)	General-purpose digital I/O pin
50	GPIO_13 Bootstrap L	(I/O)	General-purpose digital I/O pin
51	GPIO_11	(I/O)	General-purpose digital I/O pin
52	GND	-	Ground connection
53	USB2_DM	IA/OA	Negative USB connection
54	USB2_DP	IA/OA	Positive USB connection
55	GND	-	Ground connection
56	USB1_DM	IA/OA	Negative USB connection
57	USB1_DP	IA/OA	Positive USB connection
58	GND	-	Ground connection
59	+3V3_D	PI	+3V3 digital power supply
60	GND	-	Ground connection
61	BOOT_INTF_1	I	Boot source selection pin 1
62	BOOT_INTF_0	I	Boot source selection pin 0
63	ETH_LED1	O	Ethernet PHY LED1
64	ETH_LED0	O	Ethernet PHY LED0
65	GND	-	Ground connection
66	+3V3_D	PI	+3V3 digital power supply
67	+2V5_QCA	PO	+2V5 power supply to peripherals (up to 100 mA)
68	+2V5_ETH	PO	+2V5 Ethernet power supply

IA - analog input signal
I - digital input signal
I/O - digital bidirectional signal

OA - analog output signal
O - digital output signal
PI - power input
PO - power output

3. Electrical characteristics

3.1. GENERAL GPIO AND MDIO DC ELECTRICAL CHARACTERISTICS

Parameter	Units	Min	Typ	Max
High-Level Output Voltage	V	2.2	-	-
Low-Level Output Voltage	V	-	-	0.3
High-Level Input Voltage	V	1.8	-	-
Low-Level Input Voltage	V	-	-	0.4
High-Level Output Current	mA	-	-	8
Low-Level Input current	μA	-	-	15
High-Level Output Voltage (GPIO18, GPIO19, MDIO)	V	2.4	-	-
Low-Level Output Voltage (GPIO18, GPIO19, MDIO)	V	-	-	0.3
High-Level Input Voltage (GPIO18, GPIO19, MDIO)	V	2.2	-	-
Low-Level Input Voltage (GPIO18, GPIO19, MDIO)	V	-	-	0.4
Low Level Input Current (GPIO18, GPIO19, MDIO)	μA	-	-	7
Input Capacitance	pF	-	3	-
High-Level Output Voltage ¹	mV	-	1050	11953
Low-Level Output Voltage ¹	mV	2002	750	-
Output Ringing	%	-	-	10
Output Differential Voltage	mV	300		
Output Offset Voltage ¹	mV	5002	900	10703
Output Imedance (single ended) 50 Termination	Ω	40	50	60
Output Imedance (single ended) 50 Termination	Ω	60	75	90
Mismatch in a Pair	%	-	-	10
Change in Output Differential Voltage between "0" and "1"	mV	-	-	25
Change in Output Offset Voltage between "0" and "1"	mV	-	-	25
Output Current on Short to GND	mA	-	-	40
Output Current when a, b, are Shorted	mA	-	-	12
Power off Leakage Current	mA	-	-	10

1 - With 50 Ω termination

2 - When output swing set to maximum

3 - When output swing set to minimum

3.2. SGMII DRIVER AC CHARACTERISTICS

Parameter	Reference Signal	Min	Max	Comments
T _{FALL}	SGMII_SIN/SGMII_SIP	100 pSec	200 pSec	Ouput Differential Voltage Fall time
T _{RISE}	SGMII_SON/SGMII_SOP	100 pSec	200 pSec	Ouput Differential Voltage Rise time
T _{SKEW} ¹		-	20 pSec	Skew between two members of a differential pair

1 - Skew measured at 50% of the transition

3.3. MDIO TIMING CHARACTERISTICS

Parameter	Units	Min	Typ	Max
MDC Period ¹	ns	100	1450	2450
MDC High Period	%	-	50	-
MDC Low Period	%	-	50	-
Input Setup Time Requirement MDC to MDIO ²	ns	5	-	-
Input Hold Time Requirement MDC to MDIO ³	ns	0	-	-
Delay Between MDC Rising Edge and Data Toggling Edge ⁴	ns	20	-	50

1 - Configurable with the source 100 MHz or by using REF clock

2 - During read, MDIO Slave device data to be stable with respect to the rising edge of MDC clock

3 - During read, MDIO Slave device data old time with respect to the rising edge of MDC clock

4 - For MDIO write, data is output with respect to positive edge of MDC, with a delay of 20 ns or 50 ns depending on the clock selected for SPI module by using the SWITCH_CLOCK_SPARE register

3.4. MINI PCI EXPRESS RESET DC CHARACTERISTICS

Parameter	Units	Min	Typ	Max
High Level Input Voltage	V	1.8	-	-
Low Level Input Voltage	V	-	-	0.4
High Level Output Voltage	V	2.2	-	-
Low Level Output Voltage	V	-	-	0.3
Low Level Input Current	µA	-	-	7

3.5. BOOTSTRAP

Bootstrap HIGH or LOW means that during bootstrap process (first few seconds when the device is turned on) these pins need to be in the specified state. If pins are not in required state then device will not boot correctly.

3.6. GPIO

If you have some hobby project, it is advised to use GPIO pins 11, 21, 22 without any worries. These pins are not used during the booting process. Other GPIO pins should not be used if you don't know exactly what you want to achieve, because they are used during the boot process (bootstrap).

3.7. POWER SUPPLY

It is recommended to use pin 59 and pin 66 to give power supply to the module. Use 100nF ceramic capacitors for decoupling. Pin 68 has a 2.5V output to feed Ethernet interface. Pin 67 has a 2.5V output to feed peripheral devices (up to 100 mA).

3.8. POWER RATINGS

For the optimal performance and stability recommended power ratings must be used. Device might malfunction outside minimum and maximum power ratings.

Parameter	Units	Min	Nominal	Max
Supply Voltage (+3V3)	V	3.13	3.3	3.46
I/O Supply Voltage (+2V5_QCA)	V	2.49	2.62	2.75
Network Transformer Voltage (+2V5_ETH)	V	2.4	2.5	2.6
Current consumption	mA	-	-	1200

3.9. SOFTWARE

8devices is providing OpenWRT linux distribution source code with necessary patches on GitHub <https://github.com/8devices> and is supported by our growing community on <http://www.8devices.com/community> forum.

3.10. RAMBUTAN-I UNIQUE FEATURES

QCA 9550 SoC (system on chip) supports additional features comparing to QCA 9557 SoC used in a regular Rambutan module. The features are listed below:

- 5 and 10 MHz channelization supported in a 4.9 GHz frequency band only
- Loopback mode to assist FIPS AES certification
- High Tx power accuracy at lower power level
- Small packet size (96 Bytes) in AES encryption at full packet rate
- 8 bits spectral analysis resolution

3.11. OPERATING CONDITIONS

The module can operate in a wide temperature range and different conditions depending on the enclosure. The following guidelines guarantee that it will work correctly.

Parameter	Units	Min	Max
Working temperature (Rambutan/Rambutan-I)	°C	0/ -40	65/ 85
Storage temperature (Rambutan/Rambutan-I)	°C	-40	70/ 90
Humidity	%RH	10	90
Storage humidity	%RH	5	90

4. PCB footprint

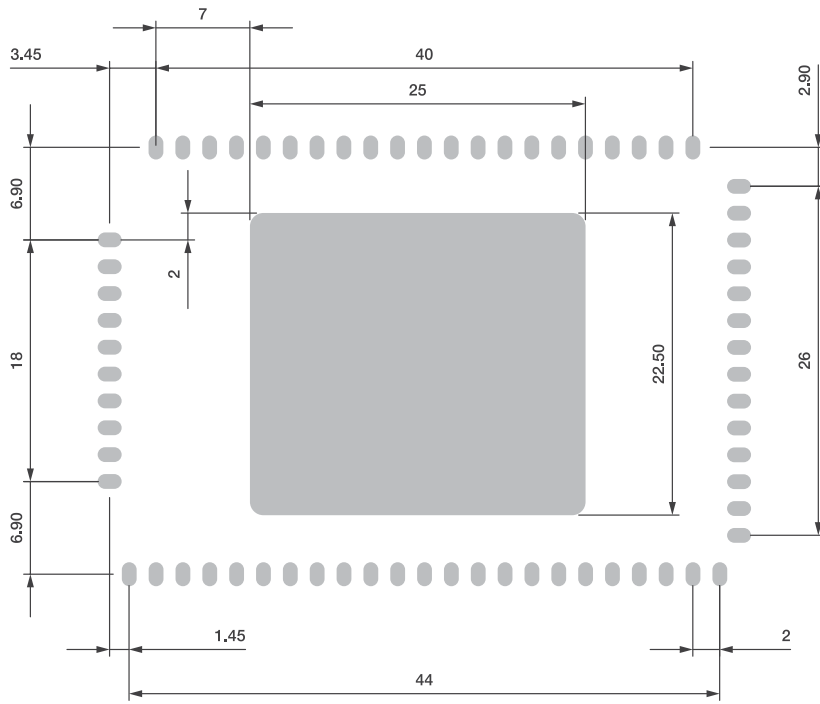

4.1 SOLDERING PASTE FOOTPRINT

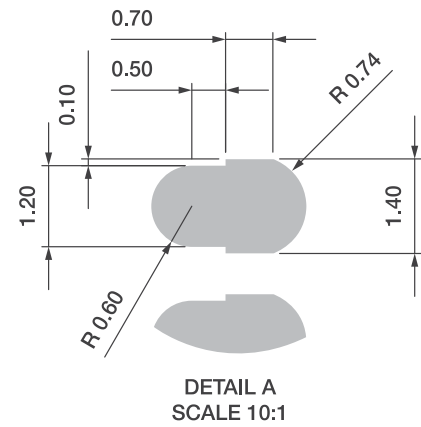

5. Reflow profile recommendations

5.1 REFLOW PROFILE PARAMETERS

Reflow profile recommendation	
Ramp up rate	3°C/second max
Maximum time maintained above 217°C	120 seconds
Peak temperature	250°C
Maximum time within 5°C of peak temperature	20 seconds
Ramp down rate	6°C/second max

5.2 REFLOW PROFILE

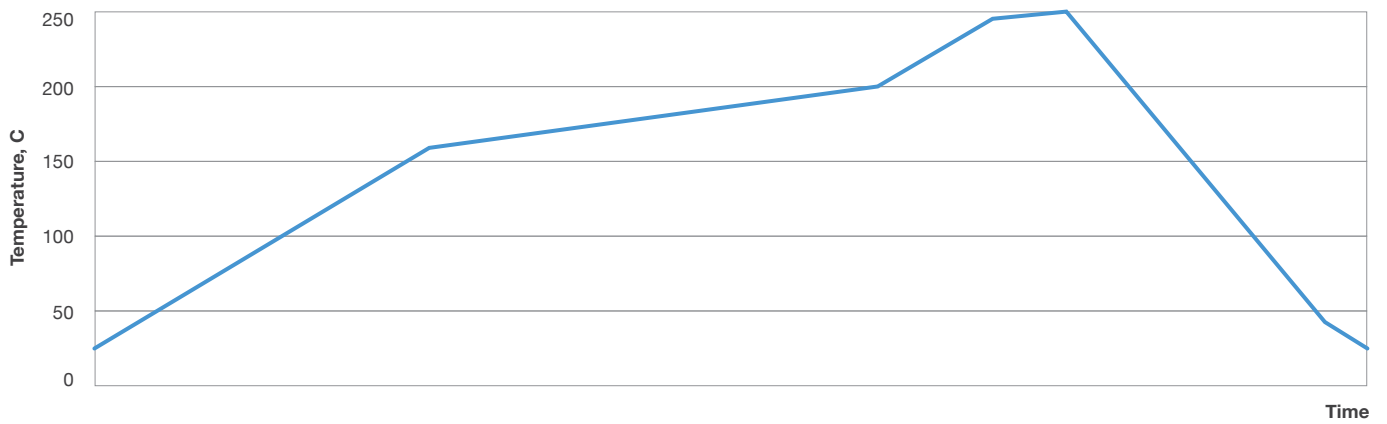

6. Radio characteristics

TABLE-6.1. 2.4 GHZ RADIO CHARACTERISTICS

Receive sensitivity (dBm)	802.11N (20 MHz)	7.2 Mbps	14.4 Mbps	21.7 Mbps	28.9 Mbps	43.3 Mbps	57.8 Mbps	65 Mbps	72.2 Mbps
		-92	-92	-91	-86	-83	-79	-77	-76
	802.11N (40 MHz)	15 Mbps	30 Mbps	45 Mbps	60 Mbps	90 Mbps	120 Mbps	135 Mbps	150 Mbps
		-90	-89	-88	-83	-80	-76	-74	-73
Output power (dBm)	802.11N 20 MHz	7.2 Mbps	14.4 Mbps	21.7 Mbps	28.9 Mbps	43.3 Mbps	57.8 Mbps	65 Mbps	72.2 Mbps
		20.5	20	20	19.5	19.5	19	18.5	18
	802.11N 40 MHz	15 Mbps	30 Mbps	45 Mbps	60 Mbps	90 Mbps	120 Mbps	135 Mbps	150 Mbps
		20.5	20	20	19.5	19.5	19	18.5	18

TABLE-6.2. 5 GHZ RADIO CHARACTERISTICS

Receive sensitivity (dBm)	802.11N (20 MHz)	7.2 Mbps	14.4 Mbps	21.7 Mbps	28.9 Mbps	43.3 Mbps	57.8 Mbps	65 Mbps	72.2 Mbps
		-96	-93	-91	-87	-84	-80	-77	-75
	802.11N (40 MHz)	15 Mbps	30 Mbps	45 Mbps	60 Mbps	90 Mbps	120 Mbps	135 Mbps	150 Mbps
		-91	-90	-88	-84	-80	-76	-74	-72
Output power (dBm)	802.11N 20 MHz	7.2 Mbps	14.4 Mbps	21.7 Mbps	28.9 Mbps	43.3 Mbps	57.8 Mbps	65 Mbps	72.2 Mbps
		18	17	17	16.5	16.5	16	15.5	15
	802.11N 40 MHz	15 Mbps	30 Mbps	45 Mbps	60 Mbps	90 Mbps	120 Mbps	135 Mbps	150 Mbps
		18	17	17	16.5	16.5	16	15.5	15

7. Module dimensions

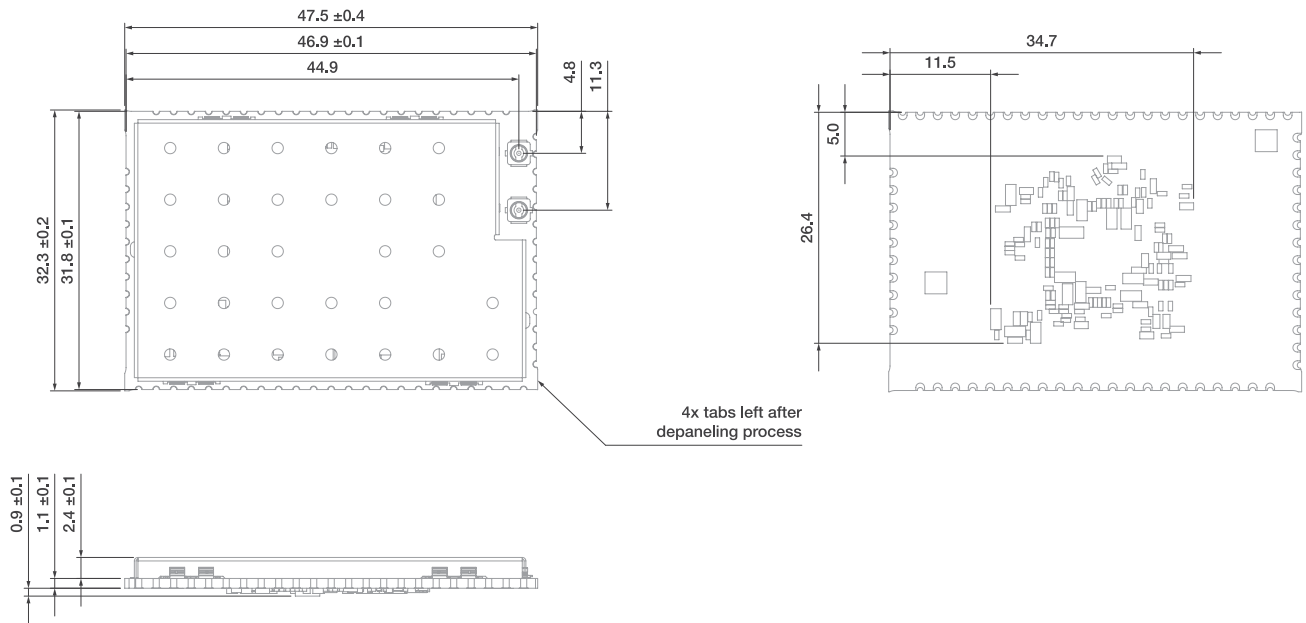

8. Development board

8.1. DVK DIMENSIONS

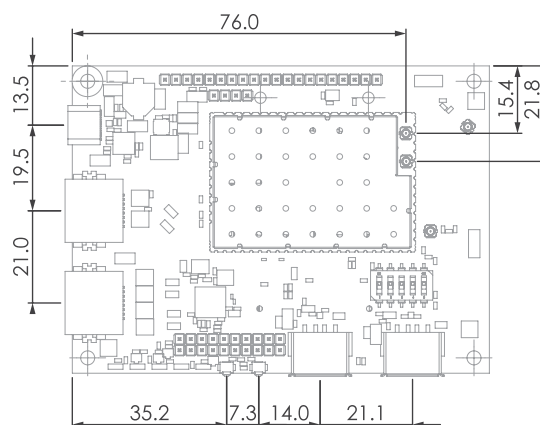
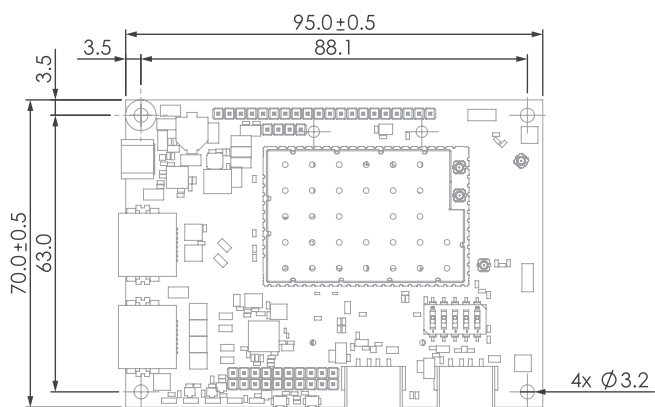
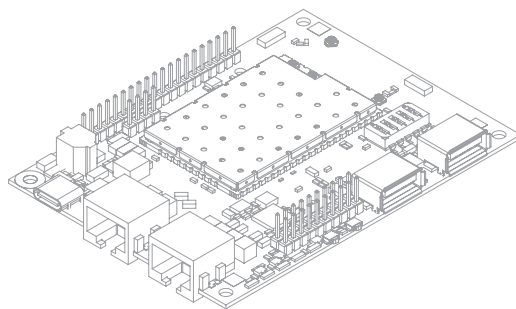
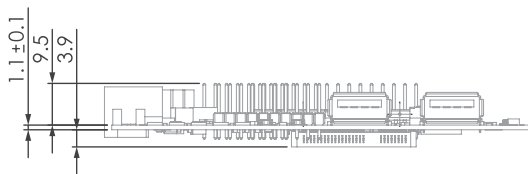

8.2. RAMBUTAN DVK

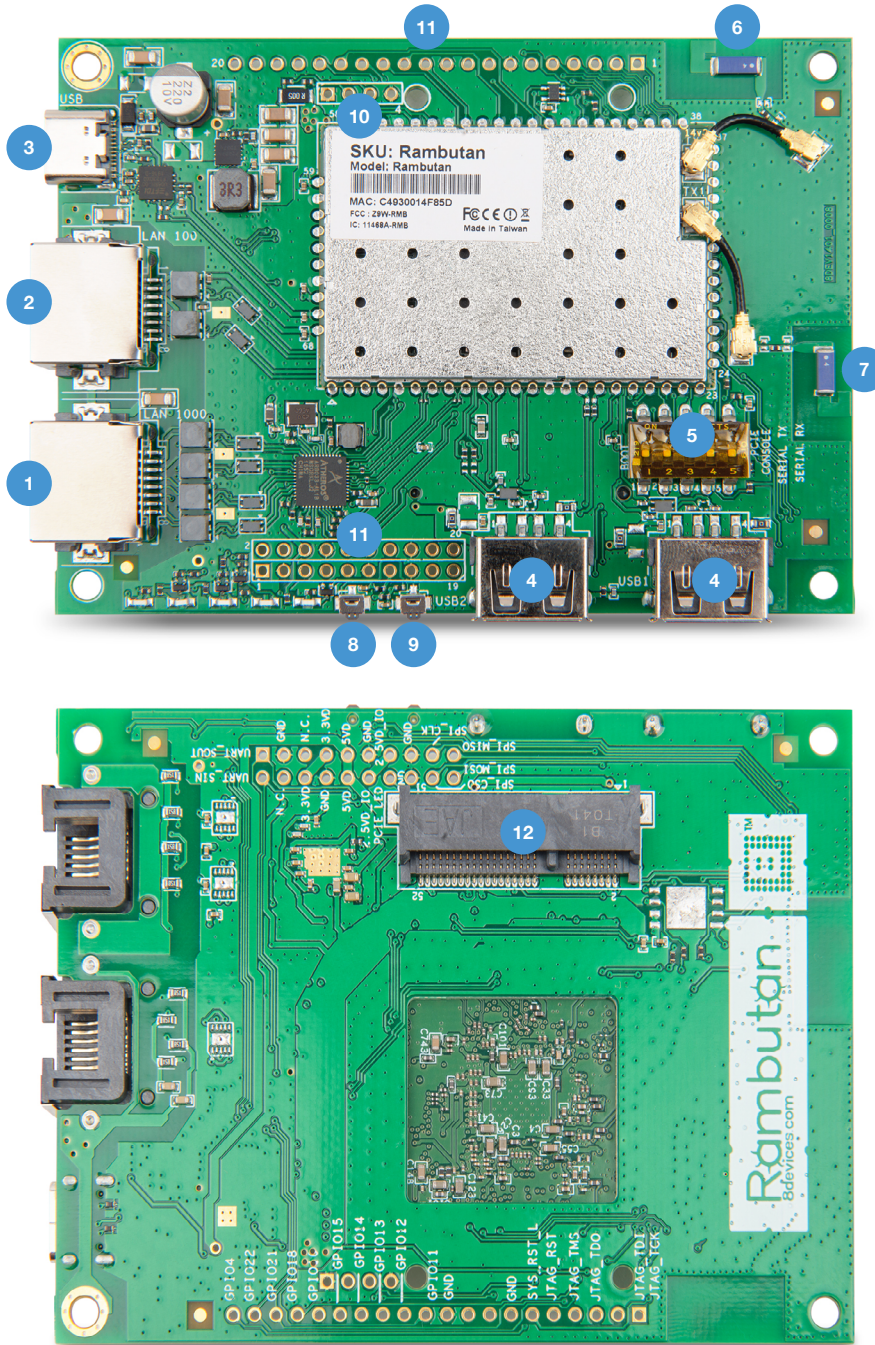

- | | |
|---|---|
| <ul style="list-style-type: none"> 1 - 1000 Base-T Ethernet port 2 - 100 Base-T Ethernet port 3 - USB Type-C connector (console UART + power) 4 - 2 x USB2.0 Type-A connector 5 - DIP switch for bootstrap configuration 6 - Chain 0 integrated Dual-band antenna | <ul style="list-style-type: none"> 7 - Chain 1 integrated Dual-band antenna 8 - Reset Button 9 - Programmable button (GPIO18) 10 - Power supply (+3.3V) and GND headers 11 - GPIO header 12 - Mini-PCIe connector PCIe 2.0 USB2.0 interfaces |
|---|---|

8.3. DIP SWITCH COMBINATIONS FOR BOOTSTRAP AND INTERFACE MODES

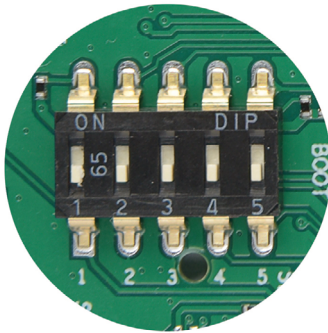

- Boot from SPI: Switch 1 ON
- Boot from PCIE: Switch 2 ON, Switch 1 OFF
- Boot from MDIO: Switch 3 ON, Switch 1 OFF
- Boot from USB: Switch 3 ON, Switch 2 ON, Switch 1 OFF
- Boot from NAND: Switch 3 OFF, Switch 2 OFF, Switch 1 OFF
- PCIE RC: Switch 4 ON
- PCIE EP: Switch 4 OFF
- USB device mode: Switch 5 ON
- USB host mode: Switch 5 OFF

8.4. HOW TO USE SECOND USB PORT?

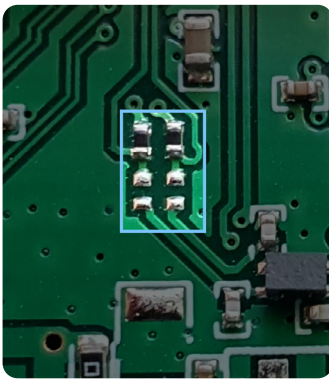

By default, Rambutan DVK has second USB port lines going to PCIe slot instead of second USB port. If you want to enable second USB port resolder 0ohm resistor from top to the bottom pads which are marked in a square area.

9. Rambutan packaging and ordering info

9.1 RAMBUTAN TRAY DIMENSIONS

Rambutan modules are packed into trays. Each tray fits 20 modules. Every 5 trays are vacuum sealed and contains 100 modules each. Standard packing box contains 500 modules.

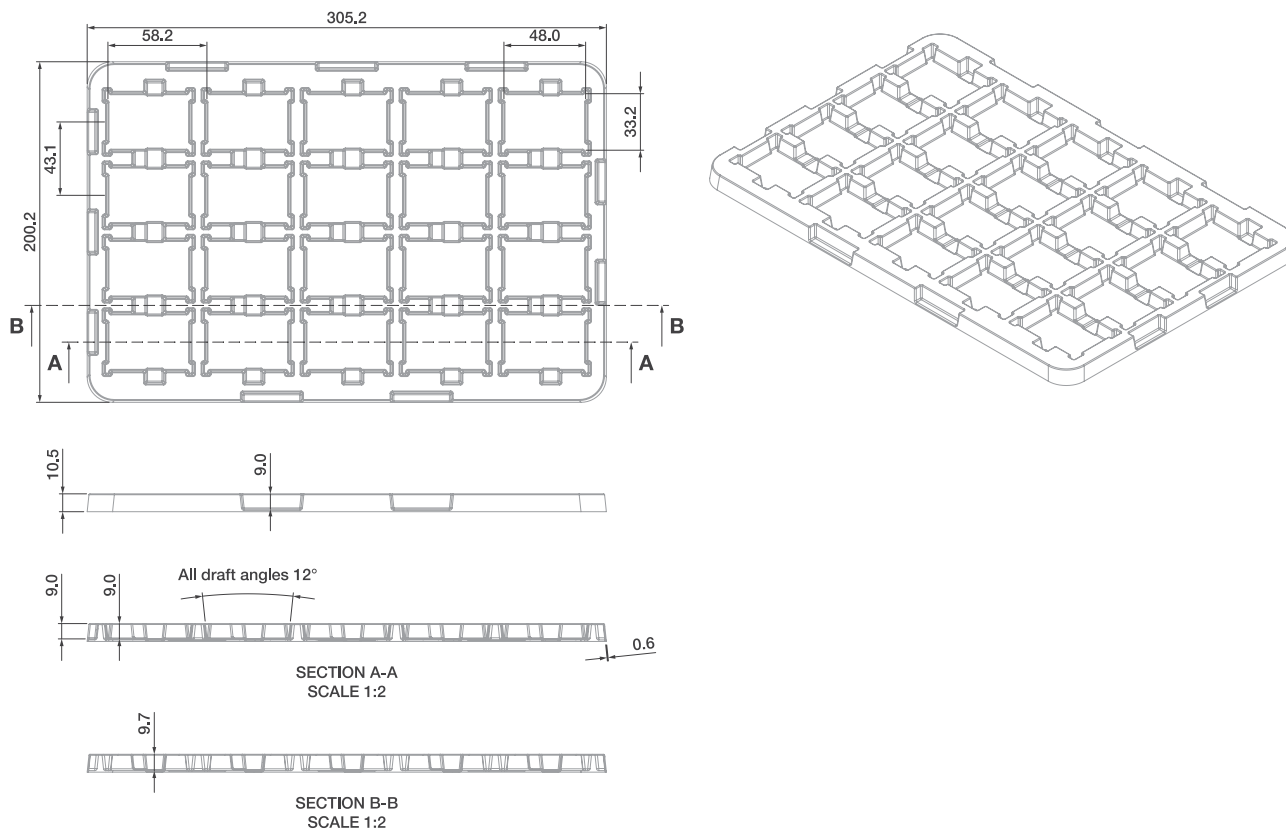

9.2 STANDARD PACKAGING BOX DIMENSIONS

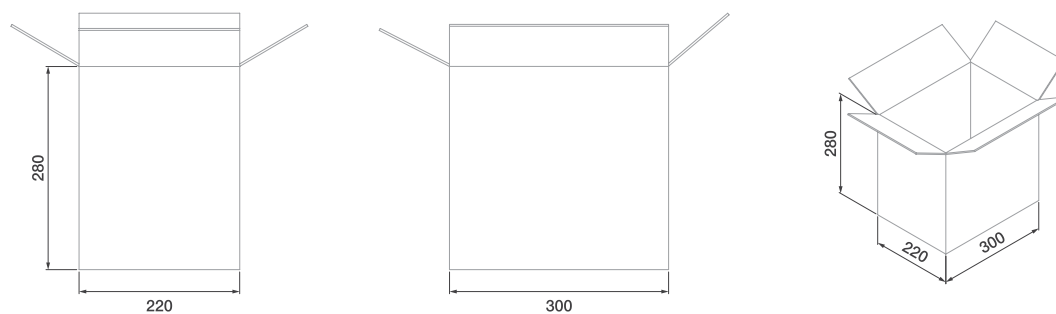

9.3 ORDERING PART NUMBERS

Order Number	Description
Rambutan	Rambutan module, commercial temperature range 0°C to 65°C, QCA-9557 SoC
Rambutan-I	Rambutan module, commercial temperature range -40°C to 85°C, QCA-9550 SoC
Rambutan-DVK	Development kit, base on Rambutan module, QCA-9557 SoC.

10. Document Revision History

Revision	Revision Date	Description
v1.0	02-10-2022	Initial release in a new format