

Kinkan is small but very versatile wireless LAN CPU module based on Realtek RTL8197FS SoC

Kinkan is packed with an extensive set of interfaces and robust 1GHz CPU based on MIPS 24Kc core. Module dimensions 19.5 mm x 26.7 mm. Back side of the module is component free and module is implemented in LGA (land grid array) form for compact surface mount designs. Built in 128MB RAM and 32MB FLASH lets comfortably run embedded Linux applications under OpenWRT.

Kinkan supports GPIO, I2C, SPI, UART, I2S, PCM/SLIC, USB2.0 host, USB2.0 host/device, PCIe, MDIO, PWM, RGMII, 100BaseT PHY, SDXC SD Card, eMMC module, SPI and parallel NAND and can boot from SD card, eMMC module built in NOR, external SPI and parallel NAND FLASH.

High performance is not affecting low power consumption with the load on LAN and WLAN interfaces it consumes up to 4W of power.

Quick specs

- 802.11 b/g/n 2.4 GHz, 2x2 MIMO, 300 Mbps data rate
- 32 MB FLASH, 128 MB RAM
- Linux friendly , OpenWRT flash image and source code are available for download on www.8devices.com/wiki_kinkan
- CPU – RTL8197FS (1 GHz CPU based on MIPS 24Kc core)
- 22 dBm per chain output power radio
- Small form factor - 19.5 by 26.7 mm
- Surface mountable (LGA form), single side design
- Available interfaces - GPIO, I2C, SPI, UART, I2S, PCM/SLIC, USB2.0 host, USB2.0 host/device, PCIe, MDIO, PWM, RGMII, 100BaseT PHY, SDXC SD Card, eMMC module, SPI and parallel NAND flash

Block diagram

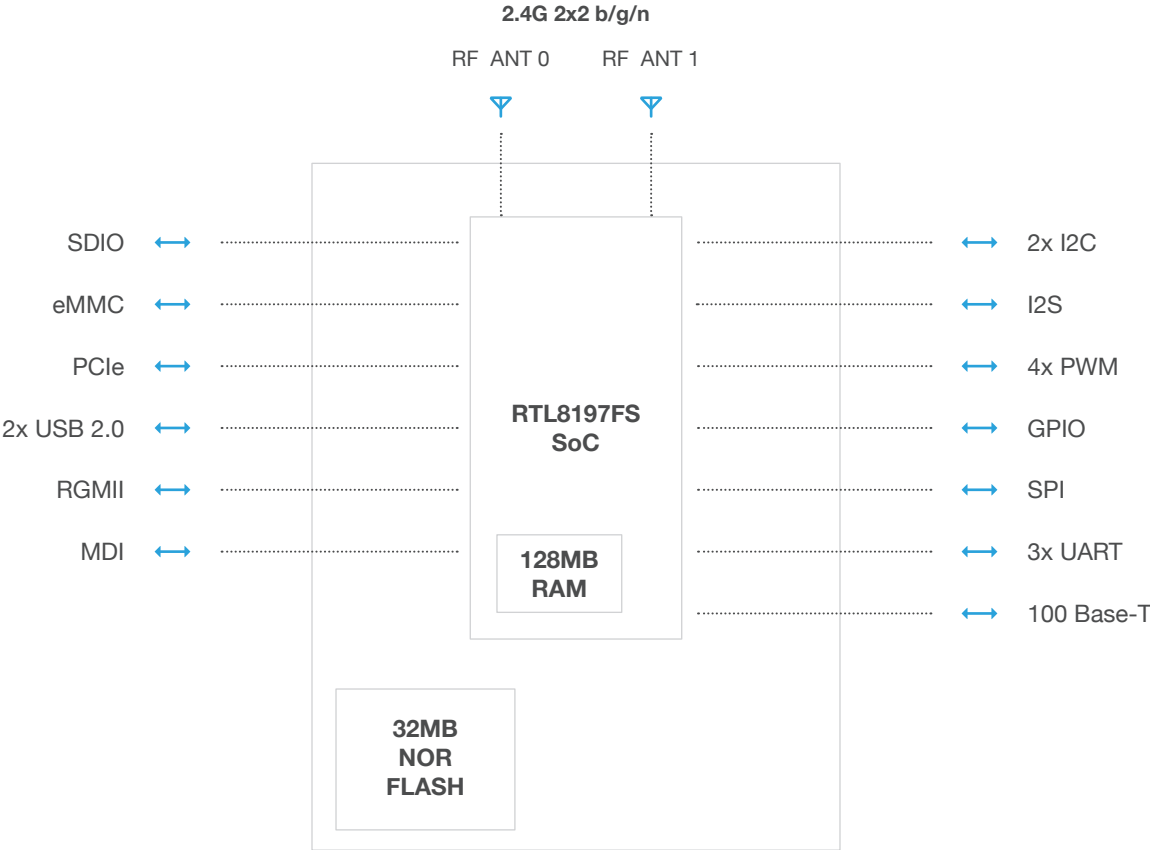

Module dimensions

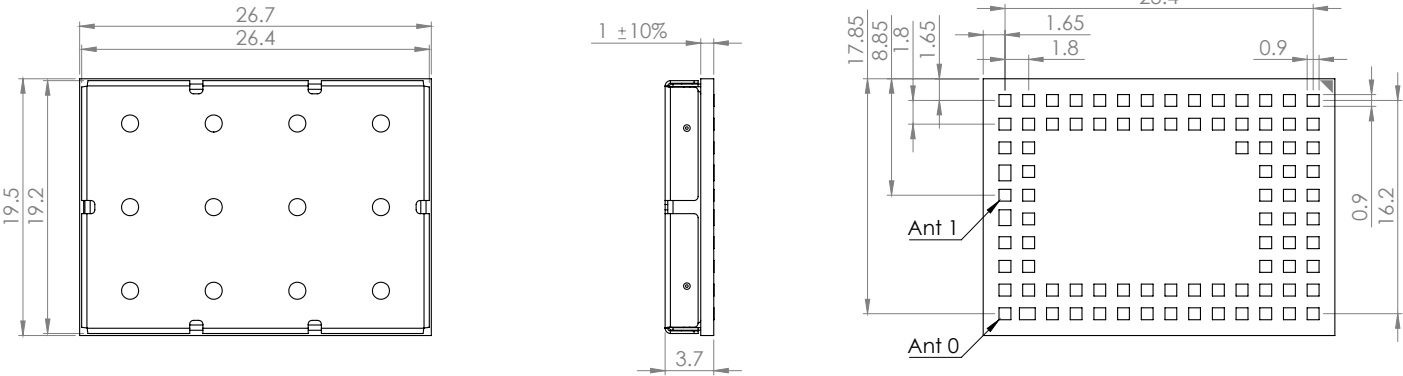

Radio characteristics

Receive sensitivity (dBm)	802.11N (20 MHz)	7.2 Mbps	14.4 Mbps	21.7 Mbps	28.9 Mbps	43.3 Mbps	57.8 Mbps	65 Mbps	72.2 Mbps
			-91	-89	-86	-84	-80	-76	-74
802.11N (40 MHz)	15 Mbps	30 Mbps	45 Mbps	60 Mbps	90 Mbps	120 Mbps	135 Mbps	150 Mbps	
		-89	-86	-84	-80	-77	-73	-72	-70

Output power (dBm)	802.11N (20 MHz)	7.2 Mbps	14.4 Mbps	21.7 Mbps	28.9 Mbps	43.3 Mbps	57.8 Mbps	65 Mbps	72.2 Mbps
			23	23	23	22	21	20	19
802.11N (40 MHz)	15 Mbps	30 Mbps	45 Mbps	60 Mbps	90 Mbps	120 Mbps	135 Mbps	150 Mbps	
		23	23	23	22	21	20	19	17

Power consumption

Scenario	Voltage, V	Current, A	Power, W
Idle without beacons	3.3	0.262	0.86
Idle with beacons	3.3	0.363	1.2
RF transmit at 50 Mbps	3.3	0.748	2.47

Operating conditions

The module can operate in a wide temperature range and different conditions depending on the enclosure. The following guidelines guarantee that it will work correctly.

Parameter	Units	Min	Max
Working environment	°C	0	55
Storage environment	°C	-40	70
Operating humidity (non condensing)	%RH	5%	90%

Module pinout

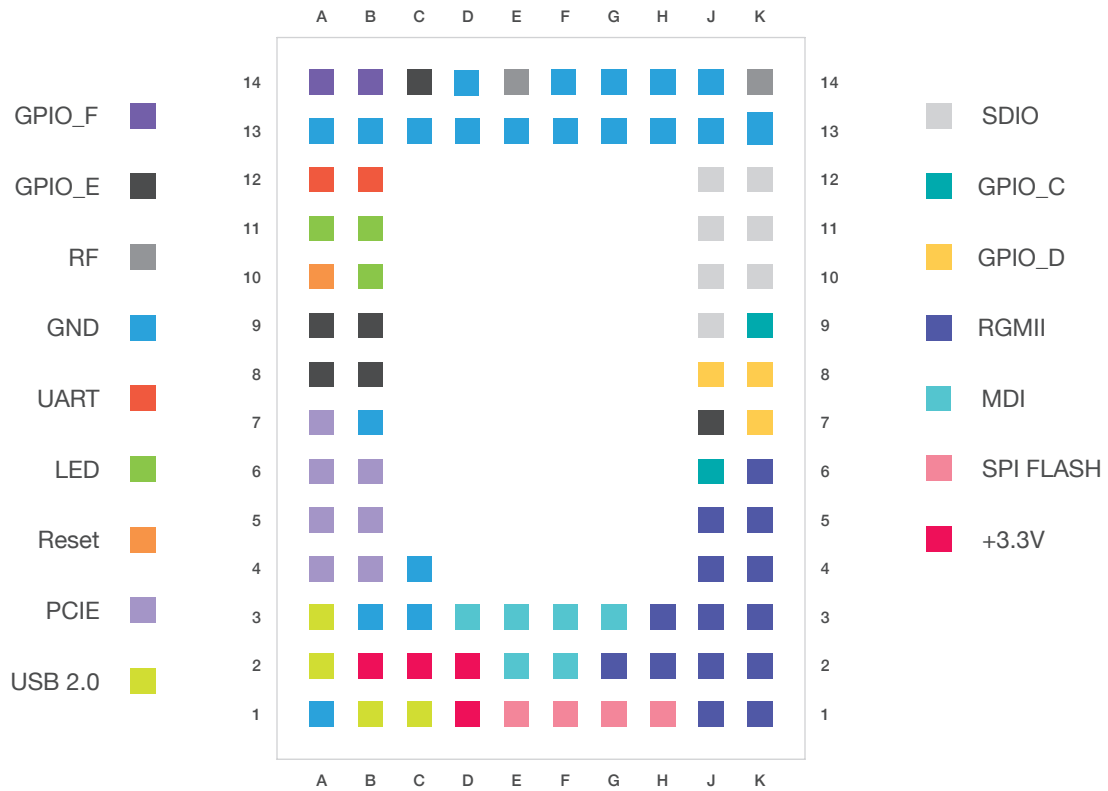

Multi-function pins, total 47

Module pin	SoC pin	GPIO	I/O	WiFi PCM	RGMII	P-Nand	I2S	SPI-N or SD-eMMC PWM EVENT	EJTAG SPI-Nand	LED SPI	UART	I2CReset
D3	29	GPIO_A[0]	O					MF_CK	SPI_NAND_CK	SPI0_CLK		I2C0_SCL
E3	102	GPIO_A[1]	B					MF_D0	SPI_NAND_D0	SPI0_TXD		I2C0_SDA
G3	96	GPIO_A[2]	B					MF_D1	SPI_NAND_D1	SPI0_RXD SPI0_TRXD		I2C1_SCL I2C1_SCL_SLV
E2	39	GPIO_A[3]	B					MF_RSTN	SPI_NAND_D2	SPI0_CS0N		I2C1_SDA I2C1_SDA_SLV
F2	41	GPIO_A[4]	O					MF_CS0N	SPI_NAND_CS0N			I2C1_SCL
F3	30	GPIO_A[5]	B				I2S_SD3_O	MF_CS1N	SPI_NAND_D3			I2C1_SDA
J1	66	GPIO_A[6]	O		P0_TXD3	NF_ALE	I2S_MCLK	PWM0		SPI0_CLK		
K3	128	GPIO_A[7]	O		P0_TXD2	NF_CLE	I2S_SCLK	PWM1		SPI0_CS0N		
G2	70	GPIO_B[0]	O		P0_TXD1	NF_RD#	I2S_WS I2S_SD2_O	PWM2		SPI0_TXD		I2C1_SCL
J3	3	GPIO_B[1]	B		P0_RXC	NF_CE0#	I2S_SD1_O I2S_SD1_I I2S_SD3_O	PWM3	JTAG TCK	SPI0_RXD SPI0_TRXD		I2C1_SDA
K6	76	GPIO_B[2]	B	PCM_CLK	P0_RXD3	NF_D0	I2S_MCLK	EVENT0	JTAG_TRSTN	SPI0_TXD_SLV	U2_RTS	
J5	5	GPIO_B[3]	B	PCM_FS	P0_RXD2	NF_D1	I2S_SCLK	EVENT1	JTAG_TMS	SPI0_RXD_SLV	U2_TX	
K5	75	GPIO_B[4]	B	PCM_TXD	P0_RXD1	NF_D2	I2S_WS	EVENT2	JTAG_TDI	SPI0_CLK_SLV	U2_RX	
J4	4	GPIO_B[5]	B	PCM_RXD	P0_RXD0	NF_D3	I2S_SD1_O	EVENT3		SPI0_CS0N_SLV	U2_CTS	

Module pin	SoC pin	GPIO	I/O	WiFi PCM	RGMI	P-Nand	I2S	SPI-N or SD-eMMC PWM EVENT	EJTAG SPI-Nand	LED SPI	UART	I2CReset
H2	71	GPIO_B[6]	O		P0_TXD0	NF_WP#		PWM0	JTAG_TDO	SPI1_CLK	U1_RTS	I2C1_SCL
J2	73	GPIO_B[7]	B		P0_TXC		I2S_SD1_I	PWM1		SPI1_CS0N	U1_RX	I2C0_SDA I2C0_SCL SLV
K1	2	GPIO_C[0]	O		P0_TXCTL	NF_WE#		PWM2		SPI1_TXD	U1_TX	I2C0_SCL
K4	74	GPIO_C[1]	B		P0_RXCTL	NF_R/B#		PWM3		SPI1_RXD SPI1_TRXD	U1_CTS	I2C0_SDA I2C0_SDA SLV
H3	77	GPIO_C[2]	B		P0_MDC					SPI0_CLK SPI1_CLK	U1_RTS	I2C0_SCL I2C1_SCL
K2	48	GPIO_C[3]	B		P0_MDIO					SPI1_CS0N SPII_CS0N	U1_TX	I2C0_SDA I2C1_SDA
K9	127	GPIO_C[4]	O					EMMC_RSTN		SPI0_CSIN		
J6	67	GPIO_C[5]	B				I2S_WS	SD_WP EVENT0		SPI0_TXD SPI1_TXD	U1_RX	
J9	69	GPIO_C[6]	B				I2S_SCLK	SD_CD EVENT1		SPI0_RXD SPI0_TRXD SPI1_RXD SPI1_TRXD	U1_CTS	
K11	10	GPIO_C[7]	B				I2S_MCLK	EMMC_CLK EVENT2		SPI0_CLK SPII_CLK		
J11	11	GPIO_D[0]	B				I2S_SD1_O	EMMC_CMD EVENT3		SPI0_CS0N SPI1_CS0N		
J10	8	GPIO_D[1]	B			NF_D4	I2S_WS	EMMC_DAT0			U1_RX U2_RX	
K10	78	GPIO_D[2]	B			NF_D5	I2S_SCLK	EMMC_DAT1			U1_CTS U2_CTS	
J12	83	GPIO_D[3]	B			NF_D6	I2S_MCLK	EMMC_DAT2			U1_RTS U2_RTS	
K12	12	GPIO_D[4]	B			NF_D7	I2S_SD1_O	EMMC_DAT3			U1_TX U2_TX	
J8	82	GPIO_D[5]	B	PCM_CLK				EMMC_DAT4 PWM0		SPI1_CLK		
K8	81	GPIO_D[6]	B	PCM_FS				EMMC_DAT5 PWM1		SPI1_CS0N		
K7	9	GPIO_D[7]	B	PCM_TXD				EMMC_DAT6 PWM2		SPI1_CS0N		
J7	79	GPIO_E[0]	B	PCM_RXD				EMMC_DAT7 PWM3		SPI1_RXD SPI1_TRXD		
B8	47	GPIO_E[1]	B	WBB0								
C14	92	GPIO_E[2]	B	WBB1								
B9	46	GPIO_E[3]	B	WBB2								
A9	110	GPIO_E[4]	B	WBB3								
A8	108	GPIO_E[5]	O	WBB4								
A14	93	GPIO_F[0]	O	WBB7								
B14	27	GPIO_F[1]	O	WBB8								
B10	43	GPIO_G[6]	B					PWM0		LED_PORT0		
B11	28	GPIO_H[0]	B					PWM2		LED_PORT2		
A10	106	GPIO_H[1]	B					PWM3		LED_PORT3		RESETN
A11	42	GPIO_H[2]	B							LED_PORT4		
A12	38	GPIO_H[3]	B								U0_RX	
B12	101	GPIO_H[4]	O								U0_TX	
B6	44	GPIO_H[5]	O									PCIE_RSTN

I/O descriptions:

B bidirectional

O output

100 Base-T MDI pins

Module pin	Function
G1	MDI_TXO4_P
H1	MDI_TXO4_N
E1	MDI_RXI4_N
F1	MDI_RXI4_P

USB pins

Module pin	Function
B1	USB1_N
C1	USB1_P
A3	USB0_N
A2	USB0_P

RF pins

Module pin	Function
K14	2G_ANT0
E14	2G_ANT1

PCIe pins

Module pin	Function
A6	PCIE_CLK_N
A7	PCIE_CLK_P
B5	PCIE_RX_N
A5	PCIE_RX_P
A4	PCIE_TX_N
B4	PCIE_TX_P

+3.3V DC power pins

Module pin
B2, C2, D1, D2

Ground pins

Module pin
A1, A13, B3, B7, B13, C3, C4, C13, D13, E13, F13, F14, G13, G14, H13, H14, J13, J14, K13

Pin status on boot

Kinkan pin	SoC pin	GPIO	HW default direction	Supported directions	Strap pin	Durig boot state (before software control)
D3	29	GPIOA[0]	Input	Output	Y	Internal pull-down only in strap period
E3	102	GPIOA[1]	Input	Bidirectional		Internal pull-up
G3	39	GPIOA[2]	Input	Bidirectional		Internal pull-up
E2	39	GPIOA[3]	Input	Bidirectional		Internal pull-up
F2	41	GPIOA[4]	Input	Output	Y	Internal pull-down only in strap period
F3	30	GPIOA[5]	Input	Bidirectional		Internal pull-up
J1	66	GPIOA[6]	Output	Output	Y	Internal pull-down only in strap period
K3	128	GPIOA[7]	Output	Output	Y	Internal pull-up only in strap period
G2	70	GPIOB[0]	Output	Output	Y	Internal pull-down only in strap period
J3	3	GPIOB[1]	Input	Bidirectional		Internal pull-up
K6	76	GPIOB[2]	Input	Bidirectional		Internal pull-up
J5	5	GPIOB[3]	Input	Bidirectional		Internal pull-up
K5	75	GPIOB[4]	Input	Bidirectional		Internal pull-up
J4	4	GPIOB[5]	Input	Bidirectional		Internal pull-up
H2	71	GPIOB[6]	Output	Output	Y	Internal pull-down only in strap period
J2	73	GPIOH[7]	Bidirectional	Bidirectional		Internal pull-up
K1	2	GPIOC[0]	Output	Output	Y	Internal pull-down only in strap period
K4	74	GPIOC[1]	Input	Bidirectional		Internal pull-up
H3	77	GPIOC[2]	Input	Bidirectional		Internal pull-up
K2	48	GPIOC[3]	Bidirectional	Bidirectional		Internal pull-up
K9	127	GPIOC[4]	Output	Output	Y	Internal pull-up only in strap period
J6	67	GPIOC[5]	Input	Bidirectional		Internal pull-up
J9	69	GPIOC[6]	Input	Bidirectional		Internal pull-up
K11	10	GPIOC[7]	Output	Bidirectional		Internal pull-up
J11	11	GPIOD[0]	Bidirectional	Bidirectional		Internal pull-up
J10	8	GPIOD[1]	Bidirectional	Bidirectional		Internal pull-up
K10	78	GPIOD[2]	Bidirectional	Bidirectional		Internal pull-up
J12	83	GPIOD[3]	Bidirectional	Bidirectional		Internal pull-up
K12	12	GPIOD[4]	Bidirectional	Bidirectional		Internal pull-up
J8	82	GPIOD[5]	Bidirectional	Bidirectional		Internal pull-up
K8	81	GPIOD[6]	Bidirectional	Bidirectional		Internal pull-up
K7	9	GPIOD[7]	Bidirectional	Bidirectional		Internal pull-up
J7	79	GPIOE[0]	Bidirectional	Bidirectional		Internal pull-up
B8	47	GPIOE[1]	Output	Bidirectional		Internal pull-down
C14	92	GPIOE[2]	Bidirectional	Bidirectional		Internal pull-down
B9	46	GPIOE[3]	Bidirectional	Bidirectional		Internal pull-down
A9	110	GPIOE[4]	Bidirectional	Bidirectional		Internal pull-down
A8	108	GPIOE[5]	Output	Output	Y	Internal pull-down
A14	93	GPIOF[0]	Output	Output	Y	Internal pull-down
B14	27	GPIOF[1]	Output	Output	Y	Internal pull-down
B10	43	GPIOG[6]	Output	Bidirectional		Internal pull-down
B11	28	GPIOH[0]	Output	Bidirectional		Internal pull-down
A10	106	GPIOH[1]	Output	Bidirectional		Internal pull-down
A11	42	GPIOH[2]	Output	Bidirectional		Internal pull-down
A12	38	GPIOH[3]	Input	Bidirectional		Internal pull-up
B12	101	GPIOH[4]	Output	Output	Y	Internal pull-up only in strap period
B6	44	GPIOH[5]	Output	Output	Y	Internal pull-down only in strap period

Power supply

It is recommended to use pin B2, C2, D1 and D2 to give power supply to the module.

Power ratings (needs update)

Parameter	Units	Min	Nominal	Max
3.3V power supply (+/-10%)	V	2.97	3.3	3.63

PCB footprint

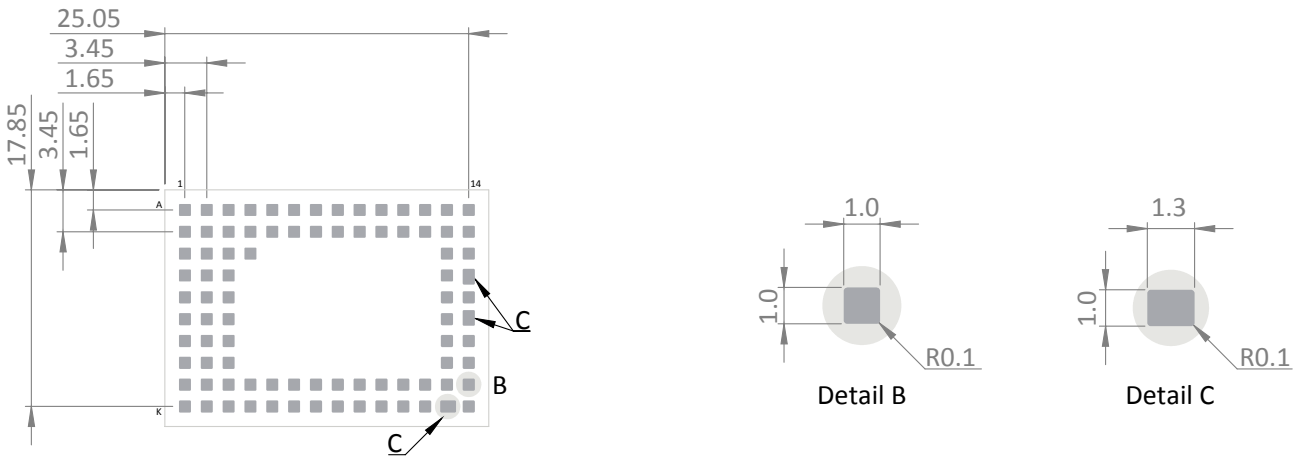

Soldering paste footprint

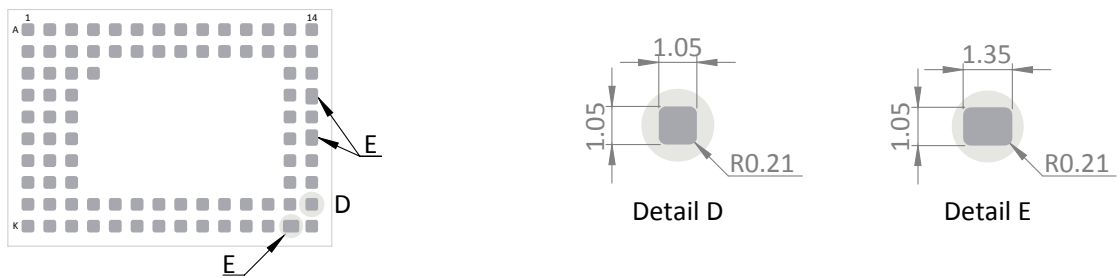

Reflow profile

Ramp up rate	3°C/second max
Maximum time maintained above 217°C	120 seconds
Peak temperature	250°C
Maximum time within 5°C of peak temperature	20 seconds
Ramp down rate	6°C/second max

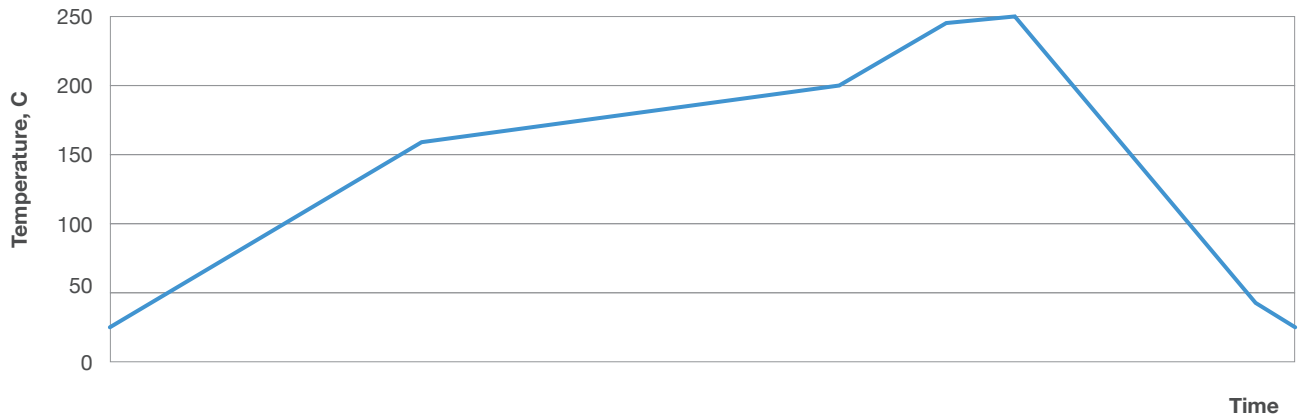

Development kit

Top view

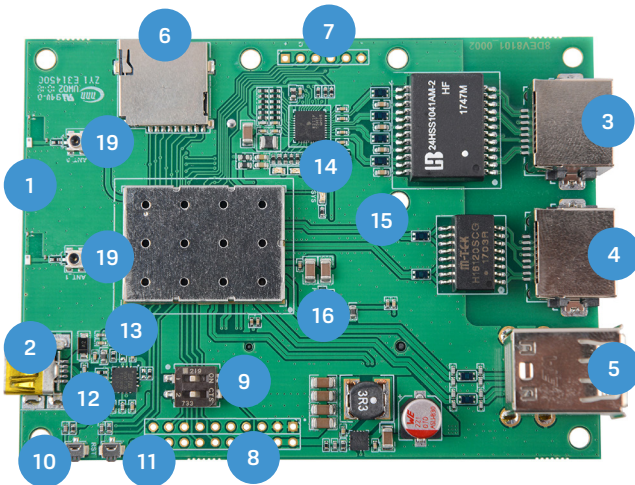

Bottom view

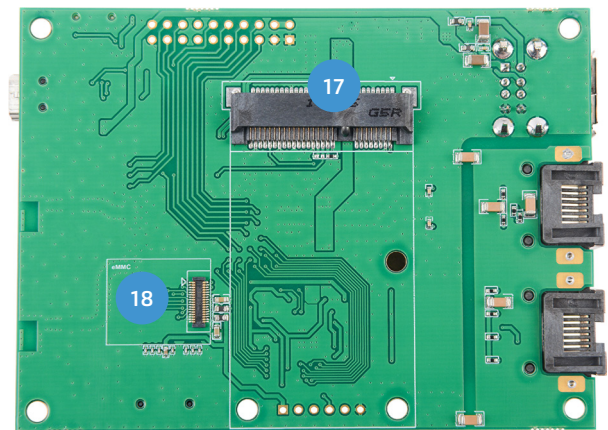

1. Ceramic 2.4 GHz omni-directional antennas
2. Mini USB Type B (console + power 5V)
3. 1000 Base-T LAN port
4. 100 Base-T LAN port
5. 2 x USB Type A (host interface)
6. Micro SD card slot
7. SPI/ GPIO pins
8. GPIO pins
9. Boot source selector switch (internal module flash, SD/emmc)

10. Button (reset to defaults)
11. Button (hardware reset)
12. UART RX/TX activity LEDs
13. Kinkan-DVK power LED
14. LAN activity LEDs
15. Programmable system LED
16. PCIe card activity LED
17. PCIe slot
18. eMMC module connector
19. Murata MM-8430 type connectors for RF testing